

**YSI Incorporated**



a **xylem** brand

## **IOEM (Input/Output) & REM (Relay) Expansion Modules**

### **Safety and Installation Guide**

AquaManger configuration quick start guides included  
at chapter 4

Item # 606524  
 Rev B  
 Drawing # 606524  
 April 22, 2015  
 Copyright  
 ©2015 YSI Incorporated.

Manufacturer:  
 YSI, Incorporated  
 A Xylem Brand  
 1700/1725 Brannum Lane  
 Yellow Springs, OH 45387 USA  
 937-767-7241  
 www.ysi.com

All trademarks herein are  
 Registered to YSI Incorporated  
 unless otherwise noted.

Microsoft and Windows are registered trademarks of the Microsoft  
 Corporation in the United States and other countries.  
 Pentium is a registered trademark of Intel Corporation.

## Table of Contents

<b>1 Introduction.....</b>	<b>7</b>
Introduction .....	8
IOEM and REM features .....	8
IOEM product description .....	10
REM product description.....	10
Preview of User Manual.....	11
Product Specifications .....	12
Environmental Specifications .....	12
IOEM Input/Output System Specifications .....	12
REM Output Specifications .....	13
Component and System (Non Input) Specifications .....	13
<b>2 Safety .....</b>	<b>15</b>
THIS IS IMPORTANT .....	16
Warnings and Cautions.....	16
Warnings .....	17
Health and Safety (calibration solutions & desiccant).....	19
Cautions .....	20
<b>3 Installation &amp; Wiring .....</b>	<b>23</b>
Hardware Installation .....	24
Step 1 Install IOEM and REM .....	25
Location Considerations.....	25
Mount the IOEM and REM .....	26
Surface Mount .....	26
Rail Mount .....	27
Install the Weather Shield.....	27
Wiring Information.....	28
PCBs .....	28
IOEM and REM Bulkhead Compression Fittings .....	30
Accessing the I/O and REM Board .....	30
Open Front Panel to Access I/O and REM Board .....	32
Close Front Panel .....	32
Step 2 Ground IOEM and REM .....	33
Directions to Ground IOEM and REM .....	33
Step 3 Wire Power .....	35
Wire AC Power .....	35
Directions to Wire AC Power .....	35
Wire DC Power and backup power .....	38
Directions to Wire DC Power/DC Backup Power .....	38
Step 4 Wire REM Relay Outputs .....	40
Directions to Wire Relay Outputs .....	41
Wiring a Contactor .....	42

Step 5 Wire I/Os on IOEM .....	43
IOEM input configuration.....	43
Directions to Wire (non temperature) IOEM Inputs .....	43
Directions to wire temperature inputs.....	46
Directions to wire 4/20mA Outputs .....	47
Step 6 Wire Network .....	48
Directions to Wire Network.....	49
Configure dip switches for slave devices .....	55
Step 7 Connect Communication Cable for Firmware Update .....	58
Directions to Wire Direct PC Connection for firmware update ..	60
Lightning and Surge Protection.....	65
Sealants, Desiccants, and Securing IOEM and REM .....	66
<b>4 Configuring IOEM and REM Channels.....</b>	<b>69</b>
IOEM and REM Configuration and Monitoring .....	70
IOEM/REM terminology .....	71
Quick Start - IOEM Configuration .....	72
Use AquaManager to configure IOEM channel mode.....	73
Configure 5X00 E-Aux system for IOEM input .....	74
Configure 5X00 system for IOEM 4/20mA output .....	76
Configure 5X00 system for IOEM PID output control device	
77	
Reset IOEM to factory .....	79
Quick Start - REM Configuration.....	80
Use AquaManager to configure REM.....	80
Configure REM relay(s) to 5X00 system(s).....	80
Reset REM to factory .....	81
Confirm latest AquaManager version is installed on PC .....	81
<b>Appendices.....</b>	<b>83</b>
Appendix 1 Unpacking and Inspection .....	84
Appendix 2 Troubleshooting .....	85
Status leds .....	85
Relay (Outputs) Troubleshooting .....	85
Network Troubleshooting .....	86
Firmware Updater Troubleshooting.....	86
AquaManager Troubleshooting .....	87
Appendix 3 Declaration of Conformity .....	88
Appendix 4 Alpha “A” curve .....	91
Appendix 5 Parts and Accessories .....	92
Appendix 6 Warranty .....	93

Appendix 7 Contact Us .....	94
Ordering and Technical Support .....	94
Service Information .....	94
Appendix 8 Recycling .....	95
Recycling .....	95
Battery Disposal .....	95
<b>Index .....</b>	<b>96</b>

---

This page left intentionally blank.

# 1

# Introduction

---

-IOEM Product Description  
-REM Product Description  
-Product features  
-Using this Manual  
-Specifications

## Introduction

Thank you for purchasing a YSI IOEM and/or REM Expansion Module(s). The IOEM-4, IOEM-8 and REM are networkable instruments that communicate with YSI 5X00 family of programmable aquatic control and alarming instruments. (The YSI 5X00 family of instruments include 5200A, 5400, 5500D-01, 5500D-02 and 5500D-04 instruments.) IOEM and REM expansion modules provide additional inputs and outputs for 5X00 instruments existing on an RS485 network. Peripheral devices wired and configured to IOEM and REM expansion modules add flexibility and capability to a network. Configure IOEM and REM expansion modules as needed for your application.

IOEM and REM instruments do not have a user interface, meaning no configuration can be done at the instrument. Use AquaManager® PC software program to configure IOEM and REM instruments.

Please see IOEM/REM terminology - page 71 for terms used throughout this manual in describing IOEM/REM instrument features and functionality.

## IOEM and REM features

IOEM and REM expansion modules share many common features. The common features are listed below. (IOEM & REM unique features are provided following the common features listed below.)

### **A 5X00 instrument is required and must be configured as the master on the RS485 network:**

- NEMA-4X / IP65 enclosure;
- universal AC power;
- optional DC 12 VDC power, including battery backup;
- \*AquaManager® PC software is required and serves as a management tool using either a direct (RS232) or TCP/IP connection where a 5X00 instrument is configured as a master on the RS485 network;
- 1 32-bit processor;
- networking capability - With a 5X00 instrument configured as the master, an additional 31 slave IOEM, REM and/or 5X00 instruments can be added to the network. The network uses RS485 protocol;
- field upgradable firmware, including RS232 port for firmware updating;
- power and communication status LEDs *see Troubleshooting; Status LED, page 85.*

\*AquaManager adds the ability to:

- configure IOEM and REM channels to 5X00 networked instruments;
- configure, graph and map IOEM systems and REM channels;
- log and view IOEM channel system data and REM events;

In addition to the common features listed above, **IOEM** functionality includes:

- 4 (IOEM-4) or 8 (IOEM-8) selectable I/Os; I/Os can be configured as digital, analog (0-1VDC, 0-5VDC, 4-20mA) or temperature inputs;
- 4 (IOEM-4) or 8 (IOEM8) selectable I/Os can be configured as 5X00 instrument system 4/20mA outputs;

In addition to the common features listed above, **REM** features include:

- four (4) onboard output relays rated at 250VAC@10AMPS;

See *IOEM and REM Product Specifications, starting on page 12*, for complete instrument specifications.

Use of this equipment for something other than the intended use of the instrument is prohibited.

Figure 1.1 shows an REM front panel and enclosure. (IOEM front panel and enclosure are identical.) Compression fittings located on the bottom of the enclosure provide liquid-tight connections for wiring peripheral devices and IOEM and REM devices and components.



Figure 1.1

## IOEM product description

IOEM instruments are configured as slave devices on an RS485 network. IOEM channels (I/Os) are used by 5X00 systems as additional I/Os on the network. IOEM instruments have either 4 I/O channels (IOEM-4) or 8 I/O channels (IOEM-8). **AquaManager (PC software) is required to configure an IOEM mode on a network.** IOEM channels can be configured in the following three (3) ways:

1. **As an Input** - configure IOEM channel as a digital, analog (0-1V, 0-5V, 4/20mA) and/or temperature input. These inputs are configured, monitored and controlled using a 5X00 instrument E-Aux system. See *IOEM input channel/eaux configuration-page 72*.
2. **As a 4/20mA PID output control device** (such as a valve) to control any 5X00 instrument pH, ORP, temperature, Conductivity, DO, non digital aux and E-Aux system. 5X00 system must be configured in PID 4/20mA control mode. See *page “Configure 5X00 system for IOEM PID output control device” on page 77*
3. **As an output, converting a 5X00 system input to a 4/20mA output signal to be used by some external device such as a PLC-** page 76- Convert any non digital 5X00 system [pH, ORP (mv), temperature (F/C), Conductivity, (mS/μS), DO (%sat/mg/l), aux and E-Aux] to a 4/20mA output signal.

**IOEM use case input-**5X00 instruments have 8 eaux systems. 5X00 instrument eaux systems are used to allow peripheral input devices (digital, analog and temperature) to be monitored, controlled and alarmed across a network. An example - a 4/20mA pH probe is configured and wired to an IOEM instrument, the 4/20mA ph probe input is configured at a 5X00 eaux system. The 4/20mA ph system can now be monitored, controlled and alarmed over the network. E-Aux “virtual systems” can be configured in a variety of ways that allow flexibility to the user.

**IOEM use case 4/20mA output** - a 5200A instrument’s pH value is sent as a 4/20mA signal to a third party device such as a PLC. The 4/20mA signal can then be used by the third party device for additional processing.

notes:

- One IOEM input can be assigned to multiple 5X00 E-Aux systems.
- One IOEM 4/20mA output can be assigned to only one 5X00 system.

## REM product description

REM instruments are configured as slave devices on an RS485 network. REM channels (outputs) are used by 5X00 systems as additional relay outputs on the network. REM instruments have 4 relay outputs that are used to connect peripheral devices. These peripheral devices are used to control and/or alarm networked 5X00 instrument systems.

**REM use case output-**The master 5X00 instrument receives information that a slave 5X00 DO system on the network is in DO low control range. The DO low control relay for this 5X00 slave is configured to relay 2 on a networked REM. The master sends a command to the networked REM that relay 2 needs to energize to control slave 5X00’s low DO value. Slave REM instrument, relay 2, energizes until the master receives a message from the slave 5X00 DO system value is  $\geq$  to that DO system’s setpoint.

note:

- Multiple 5X00 systems can be assigned to the same relays.

## Preview of User Manual

This manual includes safety, installation, wiring and maintenance information for IOEM and REM instruments. **This manual is intended to be used with 5X00 instrument manuals and AquaManager PC program help system for IOEM and REM configuration.**

Read Chapter 2 “*Safety Information,*” starting on page 16, before installing or configuring IOEM and REM systems.

Chapter 3 “*Installation,*” starting on page 24, provides information on how to install the IOEM and REM components, and peripheral devices. Only *qualified* people should install IOEM and REM expansion modules. Do not attempt to install or configure these devices if you are not *qualified* to do so. If information is not clear, DO NOT PROCEED until clarification can be obtained. All wiring involving connections to main power must be performed by a qualified licensed electrician and must conform to all locally applicable electrical codes.

Chapter 4 “*Using AquaManager to configure IOEM and REM Channels,*” starting on page 70, provides quick start guides on how to use AquaManager to configure IOEM and REM I/O channels to 5X00 instrument systems. 5X00 user manuals contain detailed information on 5X00 instrument menu structure and how to properly configure IOEM and REM instruments to 5X00 systems.

“*Notes*” are presented at the end of certain manual sections to provide additional information to help clarify IOEM and REM operation and features.

Appendices include information on Unpacking & Inspection, Troubleshooting, Declaration of Conformity, Alpha “A” curve (a reference for temperature sensors) Parts and Accessories, Warranty, Contact Us and Recycling information.

An index is provided starting on page 96.

## Product Specifications

To ensure accurate and reliable performance, operate IOEM and REM expansion modules according to specifications provided in the following tables. Damage and/or incorrect operation could result if these specifications are not followed and would not be covered under manufacturer's warranty, see page 93.

Use of this equipment for something other than the intended use of the instrument is prohibited.

Product specifications are subject to change without notice. Visit [www.yisi.com](http://www.yisi.com) to view the most recent product specifications.

## Environmental Specifications

Environmental Category	Operating Range
Temperature	0 to 45°C (32 to 113°F)
Enclosure Rating	NEMA 4X (direct exposure to outside conditions), IP65
Compression Fitting Rating	IP 68/NEMA 6 (liquid tight)
Electrical Safety	ETL Listed (Product conforms to UL 61010-1 3rd edition and CAN/CSA C22.2#61010-1 3rd edition)* EMC/ESD: Complies with FCC Part 15 (USA), ICES-003 (Canada), EMC Directive 2004/108/EC (European Union and Australia/New Zealand)*
Other	RoHS Directive 2011/65/EU, WEEE 2002/96/EC, FCC*

\*See Appendix 3 Declaration of Conformity - page 88.

## IOEM Input/Output System Specifications

Input type	There are 4 (IOEM-4) or 8 (IOEM-8) I/O channels that allow digital, analog (0-1.0VDC, 0-5.0VDC, or 4-20mA) and temperature input configuration. These inputs are configured to a 5X00 instrument's r E-Aux systems allowing for additional instrument inputs. 4-20 mA output channels can be assigned to temperature, pH, ORP, Conductivity or to Aux and E-Aux input systems. Each I/O circuit is fully isolated with its own ground.
------------	--

Digital	Range	Digital input
	n/a	dry contact open/close

Analog input ranges	Accuracy	Resolution/Other
0-1.0 VDC	0-1.0VDC: $\pm 3\% \pm 10 \text{ mV}$	user selectable (0), (0 .0), or (0.00)
0-5.0 VDC	0-5.0VDC: $\pm 3\% \pm 15 \text{ mV}$	user selectable (0), (0 .0), or (0.00)
4-20mA	4-20 mA: $\pm 3\% \pm 100\mu\text{A}$	user selectable (0), (0 .0), or (0.00)/ 4/20mA I/O circuits are able to source current as well as sink current.
Temperature Range	Accuracy	Resolution
Sensor type 10,000 ohm @ 25°C thermistor		
0 to 45°C (32 to 113°F)	$\pm 0.2^\circ\text{C}$	0.1°C
Aux Output Type	Accuracy	
4/20mA	4-20 mA: $\pm 3\% \pm 100\mu\text{A}$	

## REM Output Specifications

Outputs	4 on-board relays	250VAC@ 10AMPs switching capacity; type: SPDT.
---------	-------------------	--

## Component and System (Non Input) Specifications

Hardware		
System	System Feature	Specification
	diagnostic troubleshooting LEDs	

<b>Power:</b> There are two IOEM and REM power options. The DC version can only be powered by DC power. The AC version can be powered by AC or DC power.		
Power for DC Version:	external 12VDC power source	9-16.5VDC; 2A
Power for AC Version:	internal AC switching power supply	100-240VAC; 50-60Hz; 0.5 Amp
Both AC and DC versions:	lithium battery (for real time clock)	2032 lithium ion
Electronics	ARM7 embedded microprocessor	
Firmware		
	Feature	Specification
	Flash Memory	Firmware field upgradable with local PC connection
	Data filtering	reads 2-3 times per second and readings are averaged
Communication		
	Feature	Specification
	RS232 required for firmware upgrading	up to 100 ft (30m)
Instrument to Instrument Networking		
	Feature	Specification
	With a 5X00 instrument configured as the master, an additional 31 slave IOEM, REM and/or 5X00 instruments can be added to the network.	The network uses RS485 protocol. RS485 up to 4000 ft (1220m) entire network distance
AquaManager		
	Feature	Other PC Requirements
	Runs on Windows 2000/XP/Vista/Windows 7 & 8 Windows operating systems 32-bit and 64-bit	VGA display card CD-ROM Drive Total RAM Installed: 16MB or greater 100 MB free hard-disk space

# 2 Safety

**-IMPORTANT safety information.**  
Read this chapter before installing IOEM and REM components and peripheral devices.



## THIS IS IMPORTANT

Take time to be safe when working on electrical circuits and equipment. It could save your life. Avoid unsafe acts and conditions. Do not operate or install the IOEM and REM before reading this chapter. Installing the IOEM and REM involves wiring high voltage equipment. Follow all provided safety information. Installation must be performed by someone who understands the dangers of, and is qualified to, wire electrical devices. If information or instructions are not clear, DO NOT PROCEED until clarification can be obtained.

### ALWAYS:

**Follow basic safety rules when working with or near high voltage circuits. The IOEM and REM is a high voltage instrument using 110v. Peripheral devices may also be high voltage devices.**

**Consider the result of each act. Keep away from live circuits. Do not change parts or make adjustments inside the equipment with high voltages on.**

**Do not service alone.**



**Do not tamper with interlocks. Safety devices such as interlocks, overload relays, and fuses should never be altered or disconnected except for replacement. Safety protection devices should never be changed or modified without a clear understanding of what effect the modification will have on the system.**



**Do not ground yourself.**



**Do not energize equipment if there is any evidence of water leakage.**

## Warnings and Cautions

Safety information is presented in this manual in one of two ways:

-  - WARNING - RISK OF ELECTRIC SHOCK. This symbol identifies installation and operation procedures that can result in personal injury or death if safety information is not followed.
-  - AVERTISSEMENT – RISQUE DE CHOC ÉLECTRIQUE. Ce symbole identifie les procédures d’installation et d’opération pouvant entraîner des blessures ou la mort si les consignes de sécurité ne sont pas suivies.

-  - CAUTIONS are used when personal injury or damage to equipment can result if safety information is not followed
-  - .Les notices ATTENTION sont utilisées lorsque des blessures ou des dommages à l’équipement pourraient être causés si les consignes de sécurité n’étaient pas suivies.

These symbols ( ) appear in the left margin of the page to highlight safety information as it applies to a particular installation or operation step.





A complete list of all safety cautions is provided below. All warnings are provided in English and French.

Install and use the IOEM and REM only in accordance with information documented in this manual.









## Warnings









WARNINGS are used when personal injury or death can result if safety information is not followed.

Les AVERTISSEMENTS sont utilisés lorsque des blessures graves ou mortelles pourraient être causées si les consignes de sécurité n’étaient pas suivies.

-  WARNING: All wiring that involves connections to mains power must be performed by a qualified licensed electrician, and must conform to all locally applicable electrical codes.
-  AVERTISSEMENT : tous les câblages comportant une connexion à l’alimentation secteur doivent être réalisés par un électricien qualifié et doivent être conformes aux codes électriques applicables.
-  WARNING: Do not make connections while power is applied. Turn off power and assure power “Lockout” before installing or servicing to avoid contact with electrically powered circuits. This includes working on devices connected to the relay outputs and auxiliary input systems. **Disconnect external power to the IOEM and REM before connecting or disconnecting components and/or peripheral devices.**
-  AVERTISSEMENT: n’effectuez aucune connexion alors que le circuit est sous tension. Coupez l’alimentation et assurez l’interdiction du courant avant toute installation ou tâche d’entretien afin d’éviter d’entrer en contact avec des circuits sous tension. Cela comprend tout travail sur des appareils connectés à des sor-

ties de relais et des systèmes d'entrée auxiliaires. **Déconnectez l'alimentation externe du modèle IOEM and REM avant de connecter ou de déconnecter des composants et/ou des appareils périphériques.**

-  WARNING: A switch or circuit breaker shall be included in the building where the IOEM and REM is installed. The disconnecting device should be in close proximity to the equipment and within easy reach of the operator. The disconnecting device shall be marked for the equipment.
-  AVERTISSEMENT: un commutateur ou disjoncteur doit être installé dans le bâtiment où le modèle IOEM and REM est installé. Le dispositif de déconnexion doit se trouver à proximité de l'équipement et à portée de l'opérateur. Le dispositif de déconnexion doit indiquer l'équipement auquel il se rapporte.
-  WARNING: The covers of fuse boxes and junction boxes should be kept securely closed except when servicing.
-  AVERTISSEMENT: le couvercle des boîtes à fusibles et des boîtes de dérivation doit être maintenu fermé sauf lors des tâches d'entretien
-  WARNING: Electric sparks and chemical exposure are potential dangers when working with batteries. Use necessary precautions and follow all manufacturer's directions.
-  AVERTISSEMENT: l'exposition à des étincelles ou produits chimiques est un danger potentiel inhérent à tout travail sur des batteries. Observez les précautions nécessaires et suivez les consignes du fabricant.
-  WARNING: Ground the IOEM and REM. *See Ground IOEM and REM - page 31.* The sensitivity and stability of the IOEM and REM will be impaired if the IOEM and REM is not grounded. To avoid possible electrical shock or damage to the equipment, connect earth ground to the IOEM and REM I/O board. In addition to grounding the IOEM and REM, all tanks should be electrically grounded using a ground probe.
-  AVERTISSEMENT: mettez le modèle IOEM and REM à la terre. Voir Mise à la terre du modèle IOEM and REM. La sensibilité et la stabilité du modèle IOEM and REM seront affectées s'il n'est pas mis à la terre. Pour éviter toute possibilité de choc électrique ou d'endommagement de l'équipement, connectez le fil de terre à la carte d'E/S du modèle IOEM and REM. En plus de la mise à la terre du modèle IOEM and REM, tous les réservoirs doivent être mis à la terre.

-  WARNING: Do not overload relays. Verify that the surge current at startup does not exceed the relay load ratings. Be familiar with all safety information regarding installing and servicing peripheral devices.
-  AVERTISSEMENT: ne surchargez pas les relais. Vérifiez que la surtension de démarrage ne dépasse pas la capacité de charge nominale du relais. Prenez connaissance de toutes les consignes de sécurité concernant l'installation et l'entretien des appareils périphériques
-  WARNING: The IOEM and REM is not fused. Fuses used in any peripheral equipment should be removed and replaced only after the circuit has been de-energized. When a fuse blows, it should be replaced only with a fuse of the same current and voltage ratings. Circuits should be carefully checked before fuse replacement. A burned out fuse is often the result of circuit fault.
-  AVERTISSEMENT: le modèle IOEM and REM ne contient pas de fusible. Les fusibles utilisés par les équipements périphériques doivent être retirés et remplacés uniquement après que le circuit a été mis hors tension. Lorsqu'un fusible est grillé, il doit être remplacé uniquement par un fusible d'une tension et d'un ampérage nominaux identiques. Les circuits doivent être soigneusement vérifiés avant le remplacement d'un fusible. Un fusible grillé est souvent le résultat d'une défaillance de circuit
-  WARNING: Do not apply power to the IOEM and REM until all electrical connections are verified and secured.
-  AVERTISSEMENT: ne mettez pas le modèle IOEM and REM sous tension tant que les connexions électriques n'ont pas été vérifiées et sécurisées.
-  WARNING: Disconnect external power before wiring. Do not run high and low voltage wires through the same conduit or bulkhead fitting. Protect internal electronics. See "Sealants, Desiccants, and Securing Expansion Modules" in 5X00 User's Manual
-  AVERTISSEMENT: Déconnectez l'alimentation externe avant d'effectuer le câblage. Ne pas acheminer les câblages basse tension et haute tension dans le même conduit ou le même raccord de traversée de cloison. Protéger les appareils électroniques internes. Voir la section « Scellants, dessiccants et fixation des modules d'expansion » dans le guide d'utilisation du modèle 5X00
-  WARNING: The equipment should be positioned so that the power cord can easily be disconnected.

 AVERTISSEMENT: L'équipement devrait être placé de façon à ce que le cordon puisse être facile à débrancher.

### Cautions

CAUTIONS are used when personal injury or damage to equipment can result if safety information is not followed.

Les notices ATTENTION sont utilisées lorsque des blessures ou des dommages à l'équipement pourraient être causés si les consignes de sécurité n'étaient pas suivies.

 CAUTION: The IOEM and REM utilizes sensitive solid state devices that can be damaged by static shock. Installers must observe accepted ESD (Electro-Static Discharge) procedures while connecting wires to the IOEM and REM control board.

 ATTENTION: les modèles d'IOEM (module d'expansion d'entrée et de sortie) et de REM (module d'expansion de relais) utilisent des appareils transistorisés sensibles pouvant être endommagés par des décharges d'électricité statique. Les installateurs doivent observer les procédures de protection acceptées contre les décharges électrostatiques lors du câblage à la carte de l'IOEM et du REM.

 CAUTION: Sensors are powered by the IOEM and REM instrument and use a "floating" ground reference. This requires that the probe not be individually grounded.

 ATTENTION: Les capteurs sont alimentés par les instruments de l'IOEM (module d'expansion d'entrée et de sortie) et du REM (module d'expansion de relais) et sont utilisés comme référence « flottante » au sol. Cela exige que les capteurs ne soient pas mis à la terre individuellement.

 CAUTION: Power supply voltage above 16.5 VDC may permanently damage the IOEM and REM. *See Wire DC Power - page 38.*

 ATTENTION: Toute alimentation à une tension supérieure à 16,5 V c.c. risque d'endommager de manière permanente l'IOEM (module d'expansion d'entrée et de sortie) et le REM (module d'expansion de relais). Voir la section « Alimentation c.c. des câbles » à la page *"Directions to Wire DC Power/DC Backup Power" on page 38.*

 CAUTION: Surge protectors are strongly recommended to protect from secondary surges and lightning. Surge suppression devices should be located on the AC line supplying power to the IOEM and REM. *See Lightning and Surge Protection - page 65.*

 ATTENTION: Il est fortement recommandé d'utiliser des limiteurs de surtension pour protéger l'installation contre les surcharges secondaires et les éclairs. Les limiteurs de surtension doivent être placés sur le câblage c.a. de l'alimentation à l'IOEM (module d'expansion d'entrée et de sortie) et au REM (module d'expansion de relais). Voir la section « Protection contre les surcharges et les éclairs » à la page *"Lightning and Surge Protection" on page 65.*

 CAUTION: It is essential that all low voltage wiring, including sensor wiring be run in separate cable or conduit from high voltage wiring.

 ATTENTION: Il est essentiel que le câblage basse tension, y compris le câblage du capteur, soit acheminé par un câble ou un conduit séparé du câblage haute tension.

---

This page left intentionally blank.

## **3 Installation & Wiring**

---

-Installing & wiring OEM and REM, components, and peripheral devices.

## Hardware Installation

Correctly install IOEM and REM system components and peripheral devices to ensure accurate data collection and reliable operation. First, determine what monitor, control, alarm and output functions the IOEM and REM expansion modules will perform. Because system components are wired to IOEM and REM instruments, it is important to determine where and how components will be installed and configured. Preparing a system schematic (figure 3.1) is helpful.

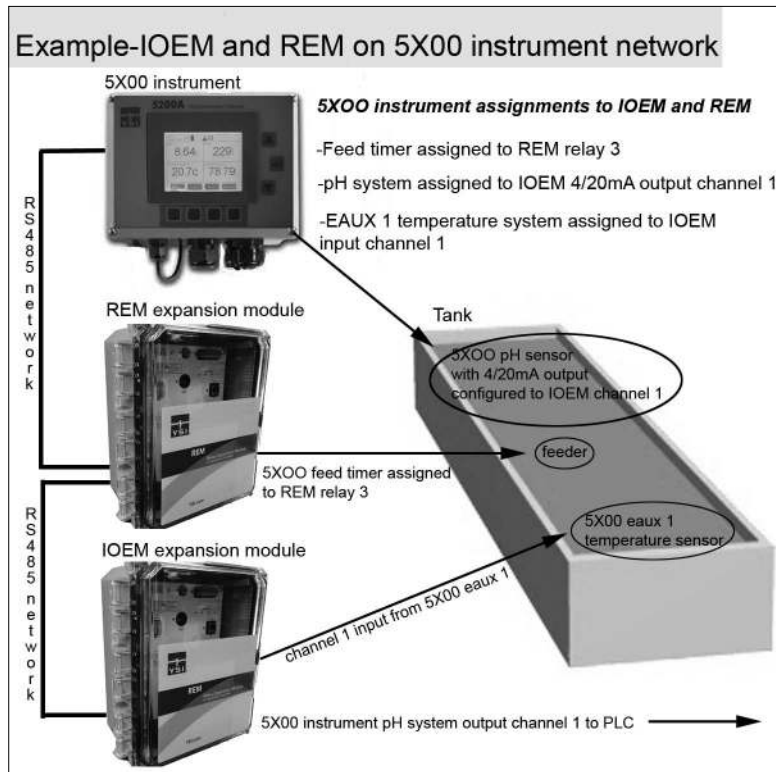

Figure 3.1

Hardware installation steps (not all steps required for all applications):

- Step 1 - install IOEM and REM instrument
- Step 2 - ground IOEM and REM
- Step 3 - wire power
- Step 4 - wire relays - REM only
- Step 5 - wire I/Os - IOEM only

Step 6 - wire a network of 2 - 32 instruments, including slave address dip switch configuration

Step 7 - wire communications hardware

See *Chapter 4 "Configuring IOEM and REM Channels,"* starting on page 70, for directions on configuring IOEM and REM expansion modules using AquaManager PC software.

Tools and supplies needed for hardware installation:

- Phillips-head screwdriver to remove IOEM and REM front panel to access board assembly
- necessary tools for cutting mounting holes in mounting brackets (rail mount)
- electric drill and bits for mounting IOEM and REM (panel or rail) and for drilling rubber grommets in bulkhead fittings
- small flat-head screwdriver to terminate wires on the IOEM and REM board's pluggable terminal strips
- wrench to tighten the bulkhead fittings following system component wiring
- wire strippers
- contactors may be required for relay wiring; see *contactor wiring* - page 42

Optional accessories for hardware installation:

- surface mount hardware (included)
- rail mount hardware
- weather shield hardware
- cabling for network wiring
- wiring not supplied with components and/or peripheral devices

## Step 1 Install IOEM and REM

Select a mounting location and method to mount the IOEM and REM.

### Location Considerations

The IOEM and REM must be located:

- above any level where water damage can occur
- away from extremely high or low temperature sources
- away from vibrating surfaces
- at least two (2) feet (.7 m) from any high voltage conduit
- away from electromagnetic, radio, AC motor, transformer, or antennas
- so the front panel can be fully opened and serviced
- so system component wires are run as specified in this manual and according to all local applicable electrical codes.

**⚠ WARNING:** The equipment should be positioned so that the power cord can easily be disconnected.

**⚠ AVERTISSEMENT:** l'équipement devrait être placé de façon à ce que le cordon puisse être facile à débrancher.

## Mount the IOEM and REM

Select surface or rail mount option. Install the weather shield for outdoor installations.

### Surface Mount

Mount IOEM and REM to any flat surface using mounting brackets. Mounting brackets and screws are included with IOEM and REM devices.

1. Fasten the mounting brackets to the back of the IOEM and REM with the mounting screws - figure 3.2.
2. Tighten the screws, securing the brackets to the back of the IOEM and REM enclosure.
3. Fasten the IOEM and REM mounting brackets to the mounting surface with the mounting screws provided - figure 3.2. Make sure screws adequately secure IOEM and REM to surface.
4. Tighten the screws, securing the IOEM and REM to the surface.

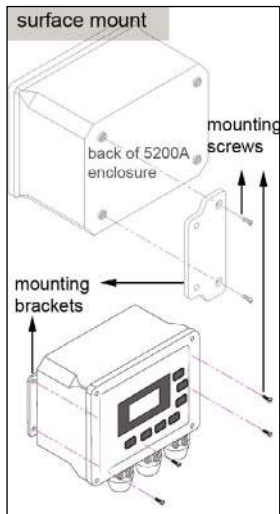

Figure 3.2

### Rail Mount

Mount IOEM and REM to handrail or pipe 1 to 1.5" (2.5 to 3.8cm) in diameter. The rail mount kit (YSI model number 6509) includes u-bolts, a pre-drilled metal plate, washers, and nuts.

1. Drill holes in the mounting brackets to fit the u-bolts. Use the pre-drilled metal plate as a template.
2. Fasten the mounting brackets to the back of the IOEM and REM with the mounting screws as shown in figure 3.2.
3. Tighten the screws, securing the brackets to the IOEM and REM.
4. Place the u-bolts around the rail securing the IOEM and REM to the pipe or rail by feeding through the pre-drilled holes on the mounting brackets as shown in figure 3.3.
5. Secure the metal plate over the u-bolts and around the rail or pipe using washers and nuts provided.
6. Tighten the screws, securing the IOEM and REM to the rail.

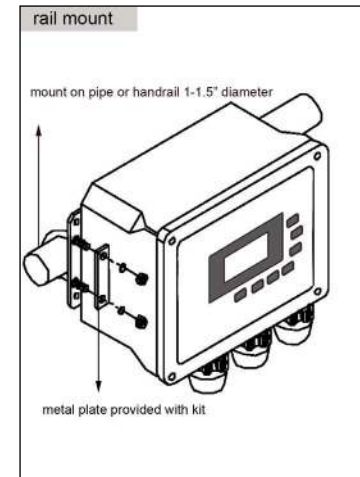

Figure 3.3

### Install the Weather Shield

Install the weather shield for outdoor installations. The weather shield can be used with either a surface or a rail mount. The weather shield kit includes a weather shield, u-bolts, pre-drilled metal plate, washers, and nuts.

1. First complete steps 1-2 under Surface Mount or steps 1-3 under Rail Mount depending on the type of installation. Note: You may need to modify the pre-drilled holes in the weather shield depending on the mounting location.
2. At step 3 (surface mount) or step 4 (rail mount), attach the weather shield to the surface or rail with the metal plate installed to secure the weather shield to the surface or rail. Figure 3.4 shows the weather shield installed for a rail mounted IOEM and REM.
3. Tighten the screws, securing the weather shield.

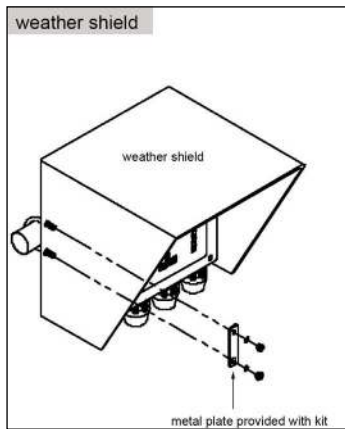

Figure 3.4

## Wiring Information



System components must be wired correctly to ensure reliable performance and accurate functionality. Directions are provided in this section for wiring all IOEM and REM components and peripheral devices. Proper Earth Ground is required to ensure safe operation—see *Wire and Ground IOEM and REM*, page 33. Power mains to be fed by a Listed/Certified 15/20Amp Breaker for SC protection.

### PCBs

There is a single pcb inside IOEM-4 and REM enclosures. IOEM-8 expansion modules have an additional pcb providing for an additional 4 I/O channels. All components including power, network, RS232 communication, inputs/outputs (IOEM) and relay outputs (REM) are wired to one board. There is a metal plate covering the PCB(s). The metal plate is labeled with letters. These letters correspond to a label, affixed to the inside of the front panel which identifies wire termination

locations. IOEM and REM ground wires (also called drain wires) are terminated to the metal plate as well.

The front panel must be open when wiring system components, peripheral devices and RS232 communication cabling. See *Accessing the I/O and REM Board* - page 32. It is recommended that some system configuration and testing be done in conjunction with hardware installation. This ensures that peripheral devices are wired correctly. Refer to Chapter 4, “*Configuring IOEM and REM Systems*,” page 70, for references to 5X00 instrument user manuals for proper configuration of all IOEM and REM instrument systems.

-  **WARNING:** Follow all safety information and local electrical codes when wiring IOEM and REM system components and peripheral devices. Proper wire gauge should be determined based on voltages and wire/cable length. Incorrect wiring can result in damage to you or to the equipment. Improper wiring can also result in ground loops.
-  **AVERTISSEMENT :** suivez toutes les consignes de sécurité et les codes électriques en vigueur lors du câblage des composants du système IOEM and REM et des appareils périphériques. Le calibre correct des câbles doit être déterminé en fonction des tensions et de la longueur des câbles/fils. Un câblage incorrect peut entraîner des blessures et endommager l'équipement. Un câblage incorrect peut également entraîner des boucles de mise à la terre.

### IOEM and REM Bulkhead Compression Fittings

Eight bulkhead compression fittings [4@ 3/8”(0.9525cm), 2 @ 3/4” (1.905cm), and 2@ 1/2” (1.27cm)] located on the bottom of IOEM and REM enclosures provide watertight connections for system component wiring-figure 3.5 Rubber grommets must be “pushed out” of the compression fitting housing and drilled for wiring installation. The drill bit diameter should be slightly smaller than the wire diameter so that a watertight seal can be made. Rubber grommets can be frozen (put in a freezer for 1 hour) and then easily drilled to the required diameter. Some pre-drilled rubber grommets are supplied with IOEM and REM. devices.

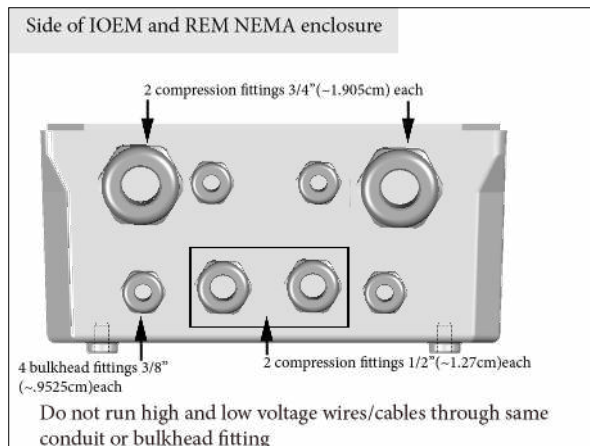
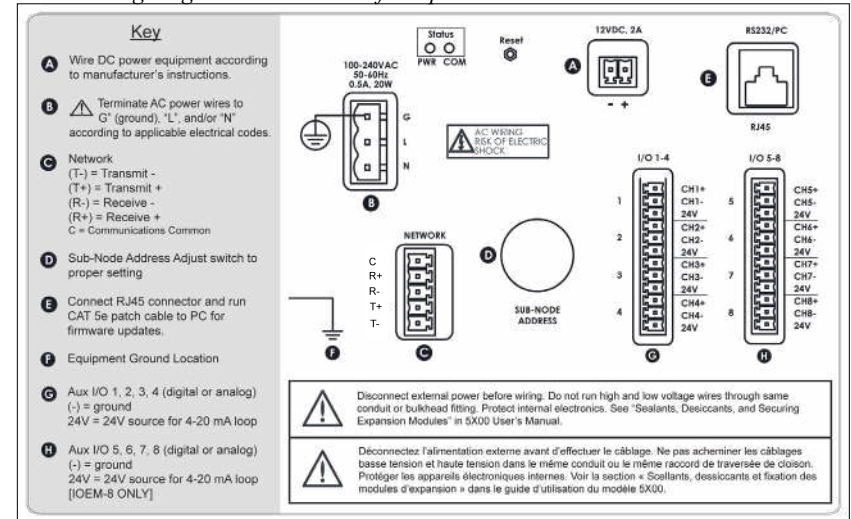

Figure 3.5

### Accessing the I/O and REM Board

The I/O board is accessible when the IOEM and REM front panel is open. The letters on the metal plate identify wire termination locations and pluggable terminal strip locations on the PCB board. Letters on the metal plate correspond to the wiring diagram located on the inside of the front panel.

### IOEM wiring diagram located inside front panel



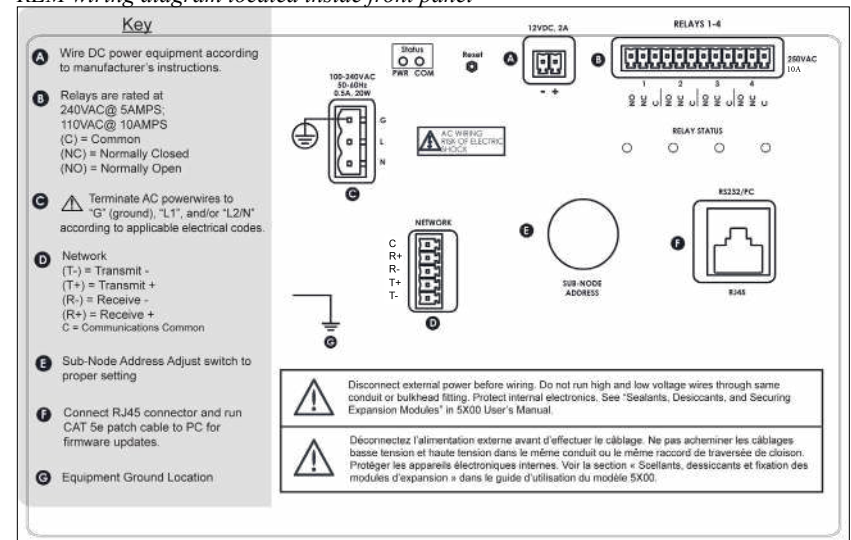

### REM wiring diagram located inside front panel





## Open Front Panel to Access I/O and REM Board

 **WARNING:** Disconnect external power to the unit before doing any wiring.

 **AVERTISSEMENT :** déconnectez l'alimentation externe de l'unité avant d'ouvrir le panneau avant.

1. Loosen the 4 mounting screws connecting the front panel to the back enclosure. Captive screws remain in front panel after loosening.
2. Unhinge the front panel by lifting the latch up so the hinge is released from the front panel. The rubber gasket seated in the front panel should remain in the front panel lid.

## Close Front Panel

1. Verify all installed components and peripheral equipment have secure connections and that there are no bare wires that could cause a short inside the enclosure.
2. Tighten bulkhead fittings after connecting all wiring. (Hand tighten fittings around rubber grommet. Tighten bulkhead fittings into enclosure with wrench being careful to not overtighten.)
3. Follow information in Sealants, Desiccants and Securing the Monitor Section - page 66 to safeguard against damage to internal electronic components.
4. Make certain the gasket in the front panel lid is in place and not twisted or damaged.
5. Tighten mounting screws, making sure not to cross thread. The screws are stainless steel, and the receiving threads are brass. Do not over-tighten!

 **CAUTION:** The IOEM and REM utilizes sensitive solid state devices that can be damaged by static shock. Installers must observe accepted ESD (Electro-Static Discharge) procedures while connecting wires to the IOEM and REM control board.

 **ATTENTION :** les modèles d'IOEM (module d'expansion d'entrée et de sortie) et de REM (module d'expansion de relais) utilisent des appareils transistorisés sensibles pouvant être endommagés par des décharges d'électricité statique. Les installateurs doivent observer les procédures de protection acceptées contre les décharges électrostatiques lors du câblage à la carte de l'IOEM et du REM.

## Step 2 Ground IOEM and REM

 **WARNING:** Ground the IOEM and REM to avoid possible electrical shock or damage to the equipment.

 **AVERTISSEMENT :** mettez le modèle IOEM and REM à la terre afin d'éviter tout risque de choc électrique ou d'endommagement de l'équipement.

Ground the IOEM at location **F** on the metal plate. Ground the REM at location **G** on the metal plate. Other IOEM and REM system components can be grounded at these same locations. Titanium ground rods can also be used to ground peripheral equipment.

In addition to grounding the IOEM and REM, all tanks should be electrically grounded via a ground probe.

## Directions to Ground IOEM and REM

 **WARNING:** Disconnect external power to the unit before wiring.

 **AVERTISSEMENT :** déconnectez l'alimentation externe de l'unité avant d'effectuer un câblage quelconque.

1. Perform step 1 of IOEM and REM installation.
2. Open front panel - page 32.
3. Remove screw from location **F** (IOEM)/**G** (REM).
4. Feed ground wire through drilled hole in rubber grommet and to location **F** (IOEM)/**G** (REM) on metal plate. Ground wire gauge must conform to all locally applicable electrical codes.
5. Install a ring (eyelet) or spade (fork) terminal onto the ground bare wire before terminating ground wire to ground location.
6. Return screw at **F** (IOEM)/**G** (REM) over terminal connection of ground wire.

 **CAUTION:** Run high and low voltage cables through separate bulkhead and conduit.

IOEM ground

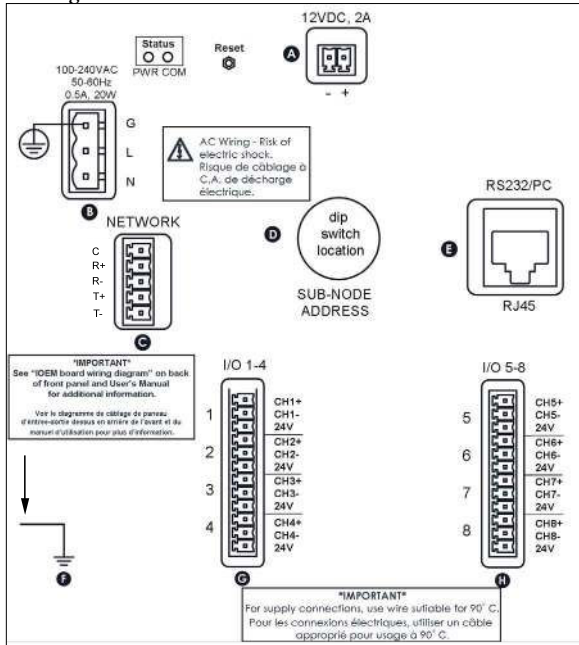

REM ground

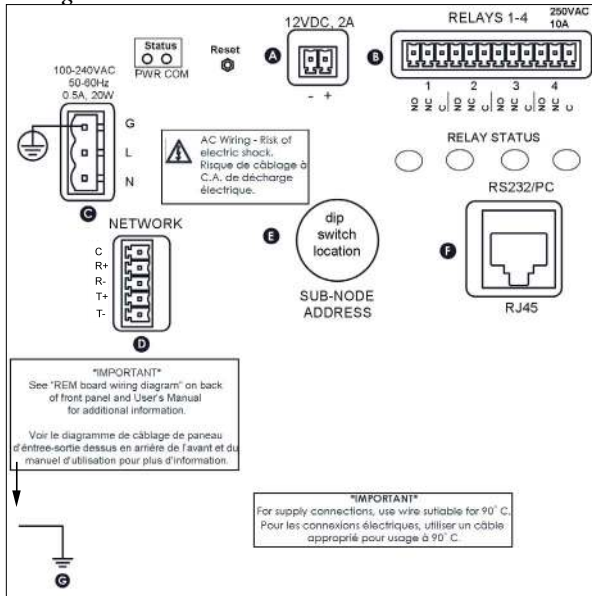

7. Terminate other end of the earth ground wire to a cold water pipe, steel rod, copper pipe, or earth ground.
8. Complete other wiring to IOEM and REM.
9. Close front panel - page 32.

### Step 3 Wire Power

IOEM and REM expansion modules are available with either AC or DC power. The DC version can only be powered by DC power. The AC version can be powered by either AC or DC. If an AC version is properly wired and configured for AC and DC backup, and AC power fails, the instrument will be powered by DC backup which supplies backup power. No user configuration is needed for the DC battery backup and low DC power alarm to function.

**CAUTION:** At 120VAC, the IOEM and REM draws 25 watts (~0.2 amps). Use wiring suitable for that load following all safety information and local electrical codes.

Back up power is recommended when operating with AC power. Backup power can be supplied by 12VDC or UPS battery source.

### Wire AC Power

The AC power option includes an integrated universal (worldwide) AC switching power supply, allowing AC power from any AC receptacle 100-240VAC. AC power wires are terminated at location C on I/O Board.

### Directions to Wire AC Power

- WARNING:** Disconnect external power to the unit before wiring.
- AVERTISSEMENT :** déconnectez l'alimentation externe de l'unité avant d'effectuer un câblage quelconque.

1. Perform steps 1 - 2 of IOEM and REM installation.
2. Open front panel - page 32.
3. Install ferrite bead on to the line cord (AC power cord). The ferrite bead (YSI p/n 606399, ferrite bead figure below) should be installed as close to the module board as possible. Strip approximately 16.5 cm (6.5 in) of insulating jacket off the end of the cord. Feed AC power cable through drilled hole in rubber grommet in compression fitting to location (IOEM) B/ (REM) C and then pass the conductors through the ferrite bead 1 time. This will result in a loop of each conductor around the bead (ferrite bead assembled figure below).

Ferrite bead (YSI p/n 606399)



Ferrite bead assembled

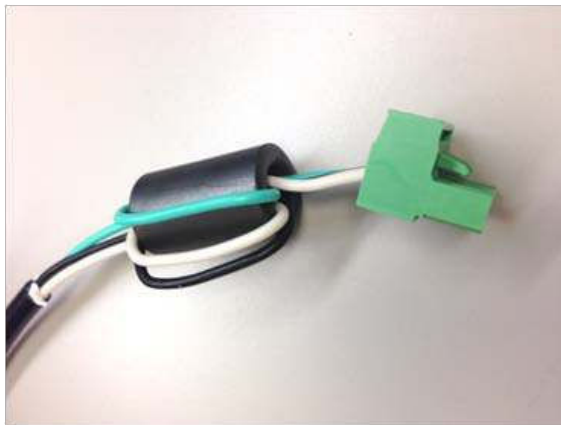

**CAUTION:** Run high and low voltage cables through separate bulkhead and conduit.

IOEM AC power

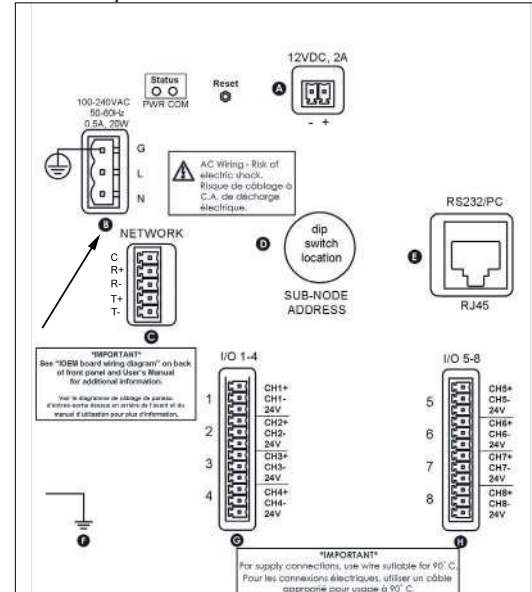

REM AC power

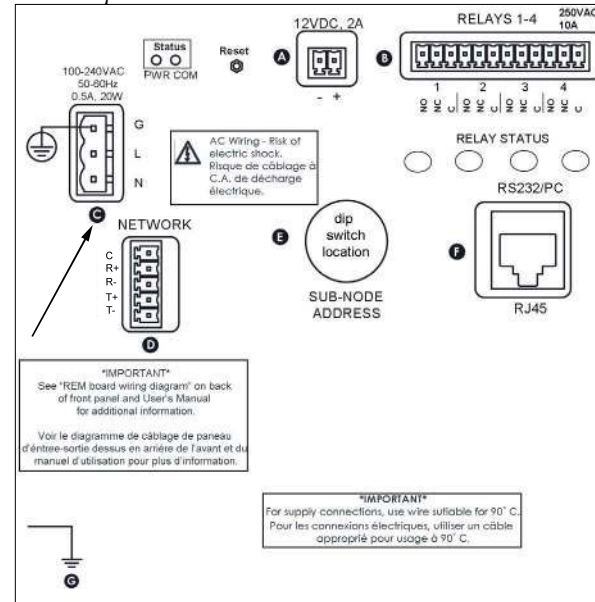

4. Terminate AC power wires to pins “G” (ground), “L1”, and/or “L2/N” according to applicable local electrical codes. Use minimum 18 gauge, 3 wire power cord.

**CAUTION:** It is recommended to use only the power cord provided to prevent exceeding the current draw of the AC power supply.

5. Complete other wiring to IOEM and REM.
6. Close front panel - page 32.
7. Test AC power. PCB PWR status led will be solid green.

### Wire DC Power and backup power

The IOEM and REM may be powered by most 9.0-16.5 VDC sources that provide 800mA of current and are isolated from mains supply by double or reinforced insulation. The DC backup power source is user-supplied and can come from a variety of choices including lead acid, gel cell, or UPS (with 12VDC transformer) external batteries. DC power wires are terminated at location **A** on the IOEM and REM boards.

Notes:

- The IOEM and REM does not charge batteries. Quality assurance maintenance procedures should be established if batteries are to be fully powered when used as back-up power source.
- Power supply voltage above 16.5 VDC may permanently damage the IOEM and REM.
- When back up voltage falls below 9.0 volts, the IOEM and REM ceases to operate properly.
- Some switching DC power supplies not supplied by YSI may result in noisy readings.

### Directions to Wire DC Power/DC Backup Power

**WARNING:** Disconnect external power to the unit before wiring. Follow all manufacturer’s safety and installation instructions when providing power to the IOEM and REM via a DC power supply.

**AVERTISSEMENT :** déconnectez l’alimentation externe de l’unité avant d’effectuer le câblage. Suivez toutes les consignes de sécurité et d’installation du fabricant lorsque vous fournissez de l’alimentation au modèle IOEM and REM par un bloc d’alimentation à courant continu.

1. Perform steps 1 - 2 of IOEM and REM installation.
2. Open front panel - page 32.

3. Feed DC power cable through drilled hole in rubber grommet to location **A**. The terminal strip is removable.

**CAUTION:** Run high and low voltage cables through separate bulkhead and conduit.

4. Terminate DC power wires to pins (-) and (+) according to manufacturer instructions and any applicable local electrical codes.

IOEM DC power

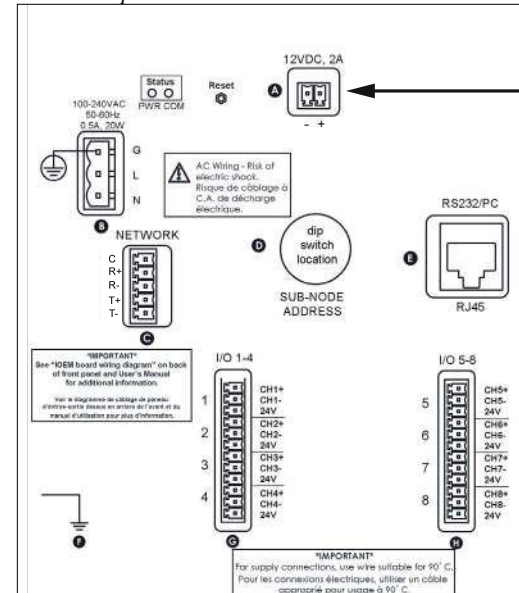

REM DC power

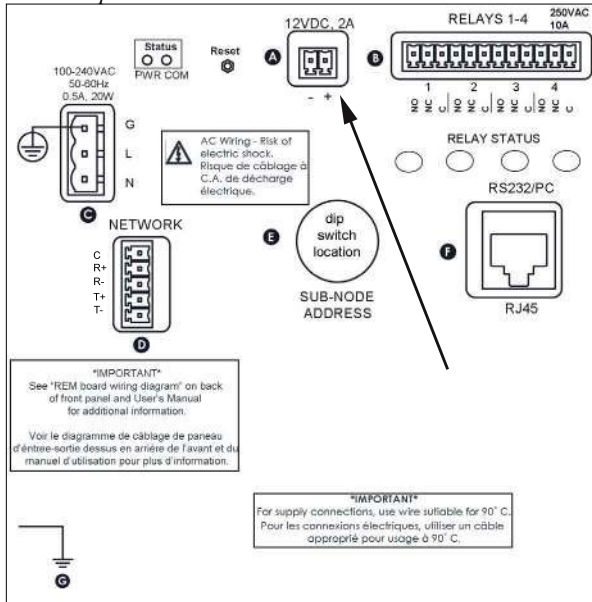

5. Complete other wiring to IOEM and REM.
6. Close front panel - page 32.
7. Test DC power. PCB PWR status led will be solid green.

Note:

- The IOEM and REM will not power up if DC power supply wires are terminated incorrectly.

### Step 4 Wire REM Relay Outputs

The REM has four (4) on board non-fused relays rated at 250VAC@10AMPS. REM relays can be configured to any 5X00 system, sensor control, alarm and timer system. Terminate relay device wires to Normally Open (NO), Normally Closed (NC), and Common (C) sockets as required for the application. (See IOEM and REM board wiring diagram on inside of front panel for identification of relay number and pin position.) Relays 1-4 are terminated at location **B**.

**CAUTION:** Do not overload relay(s). Check manufacturer specifications for inductive current/amp at power up. Use a contactor if necessary - figure 3.6.

### Directions to Wire Relay Outputs

**WARNING:** Disconnect external power to the unit before wiring. If any of the relay contacts are connected to a “hazardous-live” circuit, ALL contacts on ALL relays must be considered “hazardous-live” and appropriately protected from user contact outside the IOEM and REM enclosure.

**AVERTISSEMENT :** déconnectez l’alimentation externe de l’unité avant d’effectuer le câblage. Si un contact de relai quelconque est connecté à un circuit sous tension dangereuse, TOUS les contacts de TOUS les relais doivent être considérés comme étant sous tension dangereuse et doivent être protégés de façon adéquate de tout contact de l’utilisateur hors du boîtier du modèle IOEM and REM.

1. Perform steps 1 - 3 of IOEM and REM installation.
2. Open front panel -page 32.
3. Feed relay device wires through drilled hole in rubber grommet and to locations **B**. The terminal strip is removable.

**CAUTION:** Run high and low voltage cables through separate bulkhead and conduit.

4. Terminate relay device wires according to relay number. Wire devices to NC or NO and C pins depending on device configuration.

REM relay termination

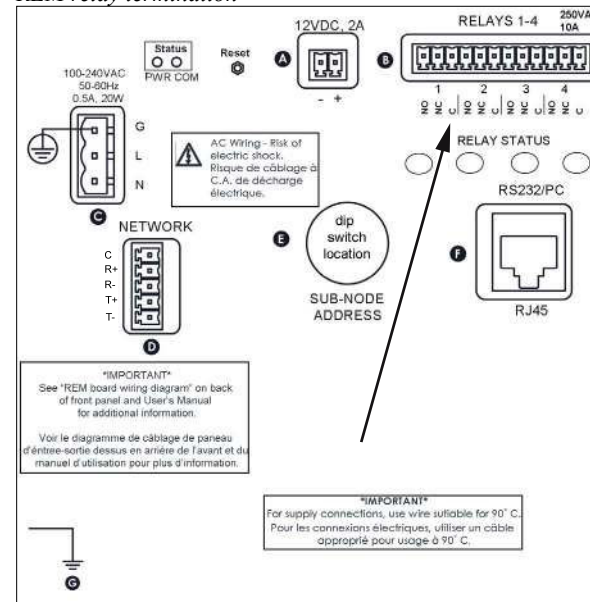

5. Complete wiring all REM relays that will be used in application.
6. Close front panel -page 32.
7. Configure 5X00 system relays using AquaManager PC software or directly through the instrument front panel. Complete relay configuration information is provided in 5X00 user manuals. Use AquaManager PC software Help system to configure relays from a PC.
8. Test relays. See *System>Service>Test Relay menu*, 5X00 instrument user manuals.

## Wiring a Contactor

The four onboard relays are rated at 250VAC@10AMPS. Contactors should be used for devices drawing current loads higher than relay specification. See figure 3.6 for contactor wiring.

Note:

- Contactor must meet the electrical requirements of the load.

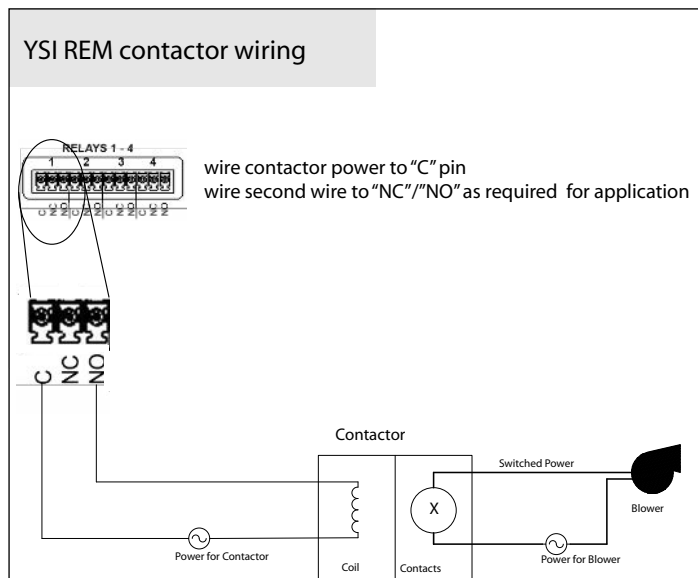

Figure 3.6

## Step 5 Wire I/Os on IOEM

Wire IOEM channel devices according to their application. IOEM channels can be configured as input or output devices. See IOEM configuration options starting on page 70. IOEM channels can be configured one of three (3) ways: 1) as an input to use with one of the 5X00 instrument's E-Aux systems which E-Aux system would be configured to monitor, control and/or alarm and datalog that E-Aux system. (E-Aux systems are also referred to as "virtual inputs.") 2) as a 4/20mA output for 5X00 sensor systems including pH, ORP, conductivity, temperature, DO and aux and E-Aux systems. The 4/20mA output signal can then be used by another connected device such as a PLC. 3) as a PID 4/20mA output for 5X00 pH, ORP, conductivity, temperature, DO, and non digital aux and E-Aux systems allowing PID control devices, such as a valve, to open and close based on system value. IOEM-8s have 8 I/Os which are terminated at locations **G** and **H**. IOEM-4s have 4 I/Os which are terminated at location **G**.

Diagrams and directions for wiring all input and output types are provided in the following manual sections. Use IOEM wiring diagram on inside of front panel for identification of I/O channel number and pin position.



## IOEM input configuration

IOEM channels can be configured for 0-1volt, 0-5volt, 4/20mA (powered and unpowered), digital and temperature input devices. These input devices use 5X00 instrument E-Aux systems to monitor, control and alarm the specific input values.

Note:

- All IOEM inputs have input protection, the maximum input voltage should not exceed 6 VDC.

## Directions to Wire (non temperature) IOEM Inputs

-  **WARNING:** Disconnect external power to the unit before wiring.
-  **AVERTISSEMENT :** déconnectez l'alimentation externe de l'unité avant d'effectuer un câblage quelconque.

1. Perform steps 1 - 3 of IOEM and REM installation.
2. Open front panel - page 32 .
3. Install input device according to manufacturer's specifications.
4. Feed aux device wires through drilled hole in rubber grommet to locations **G** and **H**. Terminal strip is removable.

**⚠ CAUTION:** Run high and low voltage cables through separate bulkhead and conduit.

5. Use (-) and (+) pin for selected input channels 1-4 for IOEM-4 and 1-8 for IOEM-8 to terminate wires. Terminate the ground wire to the (-) location. The 24V pin is used only when wiring a 4/20mA nonpowered device that requires 24V loop power from the IOEM to power the 4/20 device.
6. Please see individual diagrams for wiring IOEM input devices:
  - A. digital device, page 45;
  - B. 0-1 and 0-5 volt device, page 45;
  - C. 4/20mA (powered/sink) and (not powered/source) devices, page 46;
  - D. temperature sensor instructions (no diagram provided), page 46

**⚠ CAUTION:** Inputs are not isolated. Devices connected must be electrically isolated from ground and the water.

IOEM input and 4/20mA termination locations

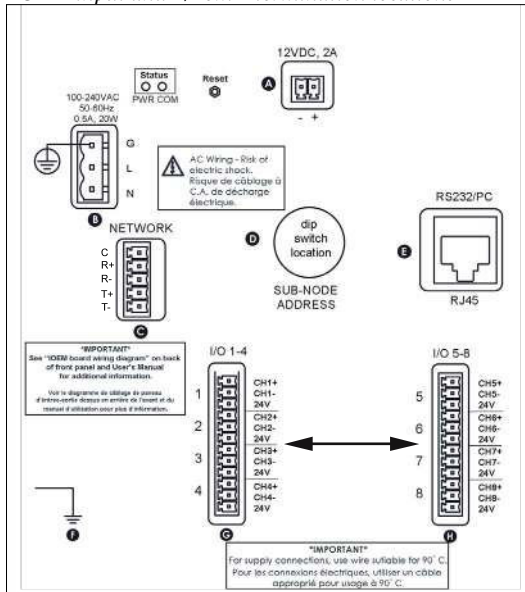

7. Complete wiring for all IOEM I/Os that will be used in application.
8. Close front panel - page 32.
9. Configure 5X00 E-Aux systems using AquaManager PC software. Complete E-Aux system configuration information is provided in the AquaManager Help system.
10. Test E-Aux/IOEM wired systems including display, control, and/or alarm functionality based on the particular user-defined configuration.

A. Wire Digital input

Wire Aux Digital Input

- Install digital input device according to manufacturer's instructions.
- Use 2 wires to connect Digital input device to an IOEM channel.
- Digital devices are mechanical and do not require power.
- Connect switch wires to an IOEM I/O channel. There is no polarity for digital input device wires; therefore, (+) and (-) terminals are interchangeable.
- Configure 5X00 Eaux systems using AquaManager PC software. Complete Eaux system configuration information is provided in the AquaManager Help system.

Digital input switch

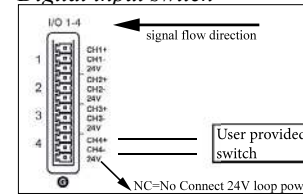

**⚠ CAUTION:** Do not input external voltage.

B. Analog 0-1 and 0-5 Volt input

Wire Analog 0-1Volt and 0-5 Volt Input

- Install 0-1 and/or 0-5 Volt analog device according to manufacturer's instructions.
- Use 2 wires to connect device to an IOEM channel.
- Follow polarity from volt source to IOEM channel (+) to (+) and (-) to (-) - see diagram below.
- Configure 5X00 Eaux systems using AquaManager PC software. Complete Eaux system configuration information is provided in the AquaManager Help system.

Analog 0-1 Volt & 0-5 Volt device

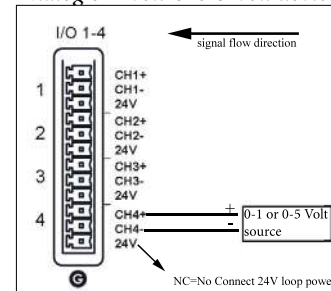

**⚠ CAUTION:** Observe correct polarity on analog input.

C. Analog 4/20mA source (not powered) and sink (powered) inputs  
**Wire 4/20mA source and sink inputs**

- Install 4/20mA analog device according to manufacturer's instructions.
- Use diagrams below to connect device to IOEM channel.
- Follow polarity from 4/20mA to IOEM channel as shown in the diagrams below.
- Configure 5X00 E-Aux systems using AquaManager PC software. Complete E-Aux system configuration information is provided in the AquaManager Help system.

Analog 4/20mA source input device

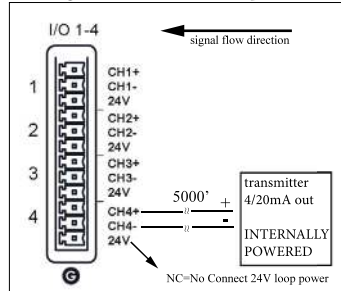

Analog 4/20mA sink input device

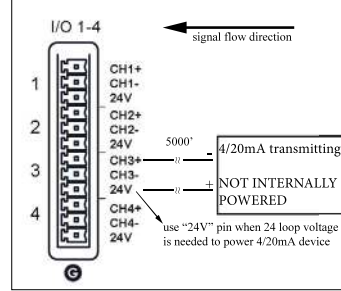

⚠ CAUTION: Observe correct polarity as shown in diagram.

**Directions to wire temperature inputs**

Any 5X00 instrument E-Aux system can be configured as a temperature input. Temperature sensors for these systems have 2 wires and are terminated at location **G** and **H** for IOEM-8 and at location **G** for IOEM-4. Temperature sensor(s) must be thermistors with 10K at 25°C, see *Appendix 4 Alpha A Curve* - page 91.

- ⚠ WARNING: Disconnect external power to the unit before wiring.
- ⚠ AVERTISSEMENT : déconnectez l'alimentation externe de l'unité avant d'effectuer un câblage quelconque.

1. Perform steps 1 - 3 of IOEM and REM installation.
2. Install temperature probe(s), see 5400 and 5500 user manual for probe installation information;
3. Open front panel - page 32.
4. Feed temperature probe cable through drilled hole in rubber grommet to location **G** and **H** for IOEM-8 and at location **G** for IOEM-4. The terminal strip is removable.

⚠ CAUTION: Run high and low voltage cables through separate bulkhead and conduit.

5. Terminate temperature sensor wires to selected IOEM channel. There is no polarity for temperature sensor wires; therefore, (+) and (-) terminals are interchangeable. Make sure temperature sensor wires are terminated at the (+) and (-) terminals for the particular Eaux channel being configuring.
6. Complete wiring to all IOEM I/Os that will be used in application.
7. Close front panel - page 32.
8. Configure 5X00 E-Aux systems using AquaManager PC software. Complete E-Aux system configuration information is provided in the AquaManager Help system.
9. Test E-Aux/IOEM wired systems including display, control, and/or alarm functionality based on the particular user-defined configuration.

**Directions to wire 4/20mA Outputs**

5X00 instrument systems including pH, DO, temperature, conductivity, ORP, E-Aux and aux can be configured to **output** a 4/20mA signal that can then be connected to a non powered device, like a PLC, allowing use of the 4/20mA signal by other programs. See the diagram below to wire a 4/20mA output

- ⚠ WARNING: Disconnect external power to the unit before wiring.
  - ⚠ AVERTISSEMENT : déconnectez l'alimentation externe de l'unité avant d'effectuer un câblage quelconque.
1. Perform steps 1 - 3 of IOEM and REM installation.
  2. Open front panel - page 32 .
  3. Feed 4/20mA output wires through drilled hole in rubber grommet to location **G** and **H** for IOEM-8 and at location **G** for IOEM-4. Terminal strip is removable.

⚠ CAUTION: Run high and low voltage cables through separate bulkhead and conduit.

4. Use (+) and (-) pins for wire terminations that will relay 5X00 system 4/20mA signal to external device, such as a PLC-see diagram below.

note:  
 - 4/20mA outputs can only source current, 4/20mA outputs cannot sink current.



B. 4/20mA Analog output

Wire 4/20mA 5X00 instrument Analog output

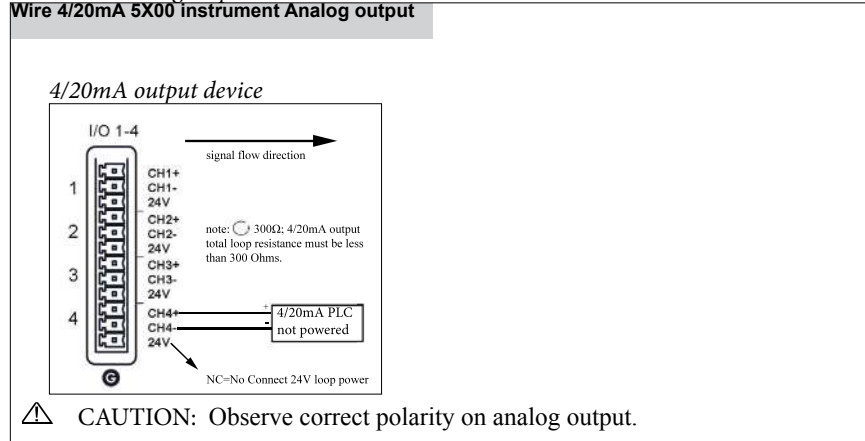

⚠ CAUTION: Observe correct polarity on analog output.

5. Complete wiring to all IOEM I/Os that will be used in application.
6. Close front panel - page 32.
7. Configure 5X00 system using AquaManager PC software as 4/20mA output. Complete E-Aux system configuration information is provided in the AquaManager Help system.
8. Test E-Aux/IOEM 4/20mA signal output at PLC device.

### Step 6 Wire Network

Multiple IOEM and REM, 5400 and 5500D-01, 5500D-02, 5500D-04 instruments are networked using the RS485 network port. A node network consists of one master and up to 31 slaves. The master can never be an IOEM or REM instrument. On a network, the master is the point of access for the AquaManager PC software.

RS485 network wiring can span distances up to 4000 feet (1220m). This maximum distance (4000 ft) is for the total network distance, not the distance between networked units (\*see Notes below). RS485 ports are optically isolated for safety, to reduce noise, and to help eliminate ground loops. No further isolation is required.

Network traffic refers to the constant communication between the master and all slaves on the network. For example, if a slave 5200A pH system is configured to have a slave REM relay 4 dose up when in control range, and the 5200A is in pH control range. The 5200A slave delivers this information to the master and the master relays this information to the REM over the RS485 network and relay 4 is energized.

Notes:

- \*Use an RS485 Line Extender/Booster for distances over 4000' (1220m). Communication failures may occur without it. Mount the booster in an area where it is protected from moisture.
- Network traffic speed operates at ~ 230 KB and is not user selectable.
- Remove network terminal strip from any networked slave that is not powered. Network rewiring is required if a stub (\*\*see next note) is created when a slave is taken off the network. See valid network configuration - figure 3.12, page 54

Note:

- \*\*A stub is created when the last wired network terminal strip is not connected to a network slave - figure 3.9.

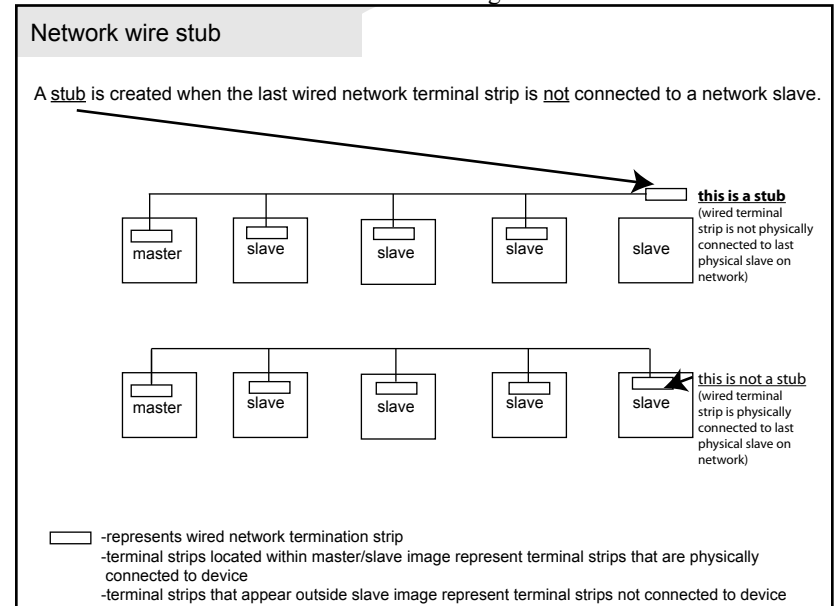

Figure 3.9

### Directions to Wire Network

Network wiring consists of **two pairs of twisted pair cable plus a communications common wire**. Category 5 ethernet cable is recommended. Network wires are terminated at location **G** IOEM and **D** REM.

**WARNING:** Disconnect external power to the unit before wiring.

**AVERTISSEMENT :** déconnectez l'alimentation externe de l'unité avant d'effectuer un câblage quelconque.

1. Perform steps 1 - 4 of IOEM and REM installation.
2. Open front panel -page 32.
3. Strip five wires to terminate at network termination strip. Use appropriate wire stripper to avoid wire nicks.
4. Feed networking cable through drilled hole in rubber grommet and to location **C** IOEM and **D** REM. Terminal strip is removable.

Note:

- It is essential that wires be terminated cleanly. Nicks (stray wires, not cleanly terminated) can result in unreliable network communication.

**CAUTION:** Run high and low voltage wires/cables through separate bulk-head and conduit.

*IOEM network*

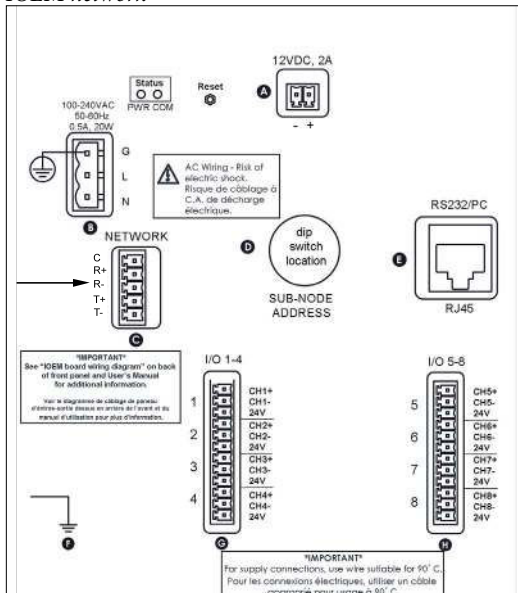

*REM network*

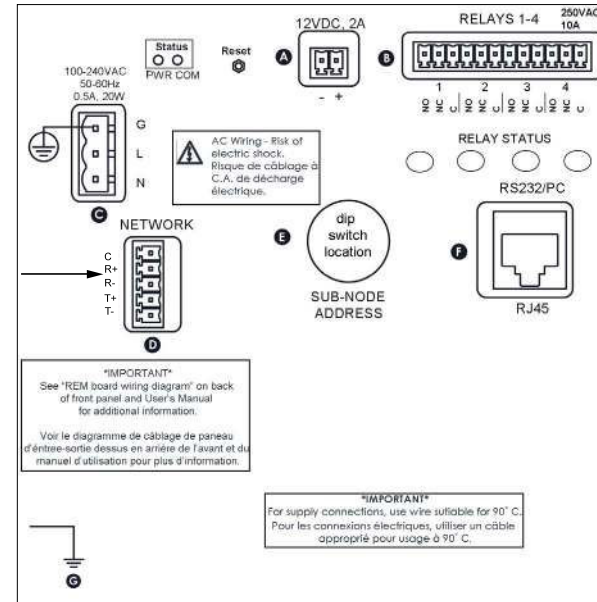

5. Terminate wires as described using category 5 cable: (color scheme may be different than described below.)
  - Pair #1 wires: solid blue and white with blue stripe
  - Pair #2 wires: solid orange and white with orange stripe
  - 1 wire green
  - Secure unused wires to avoid potential for shorting

**Wire the master as follows:**

Wire Color	Terminal
solid orange	T (-)
white with orange stripe	T (+)
solid blue	R (-)
white with blue stripe	R (+)
green	Communications Common (C)

**Wire all slaves as follows:**

Wire Color	Terminal
solid blue	T (-)
white with blue stripe	T (+)
solid orange	R (-)
white with orange stripe	R (+)
green	Communications Common (C)

Figure 3.10 is a wiring diagram for the most common IOEM and REM network configuration where a master 5X00 instrument is the first physical device in the network.

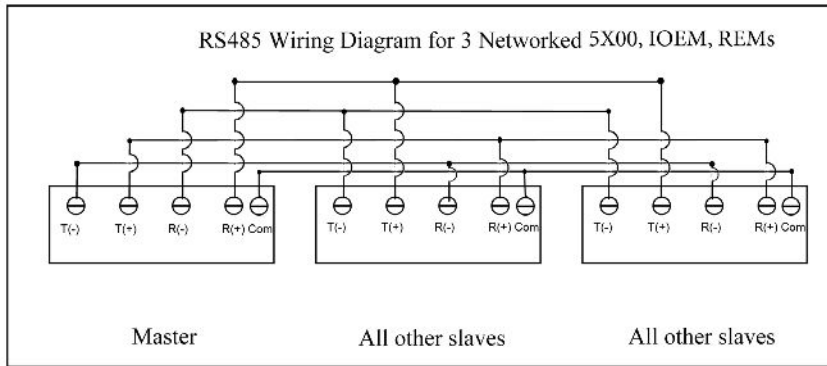

Figure 3.10

6. **Wire all network terminal strips prior to network testing, but only connect a network terminal strip to the first and last devices on the network** (\*see note below). Network testing cannot be done if stubs exist (\*\* see note below).
7. Configure dip switches for all IOEM and REM slave instruments on the network. See configure dip switches for slaves - page 55.

Notes:

- For testing - If the master is not the first physical device on the network, place network terminal strip on the master and on the first and last physical devices on the network. (In this case two slaves will need to be tested at the same time.) - figure 3.11 on next page .
- The network must not include any stubs. \*\*A stub is created when the last wired network terminal strip is not connected to a network slave - figure 3.9 - page 49.

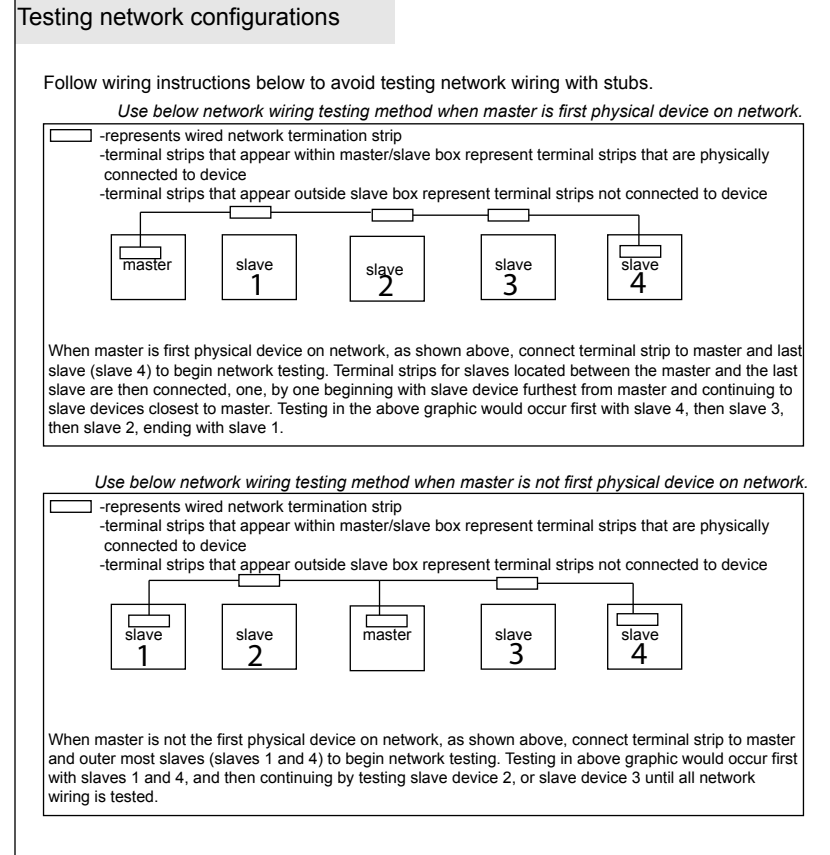
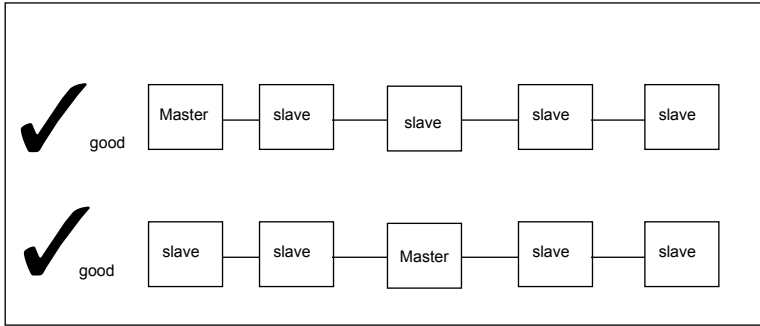

Figure 3.11

IOEM and REM networks must be configured point-to-point (instrument-to-instrument). Network wiring cannot contain loops, stars, or stubs - figure 3.12, page 54.

**Network configurations**



follow master/slave wiring directions figure 3.26

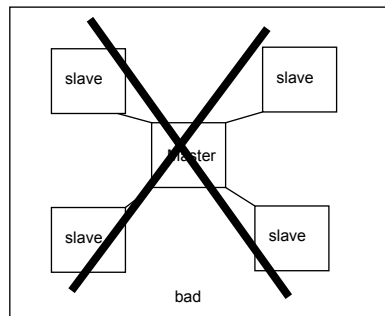

do not wire "star" network

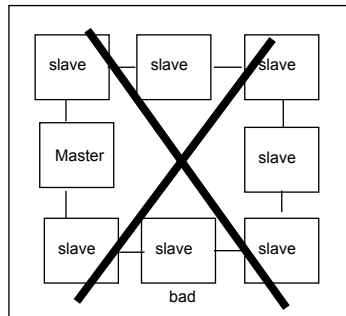

do not wire "loop" network

Figure 3.12

**Configure dip switches for slave devices**

Dip switches are used to set the network slave address. Dip switches are set at **D** IOEM **E** REM locations

*IOEM dip switch location*

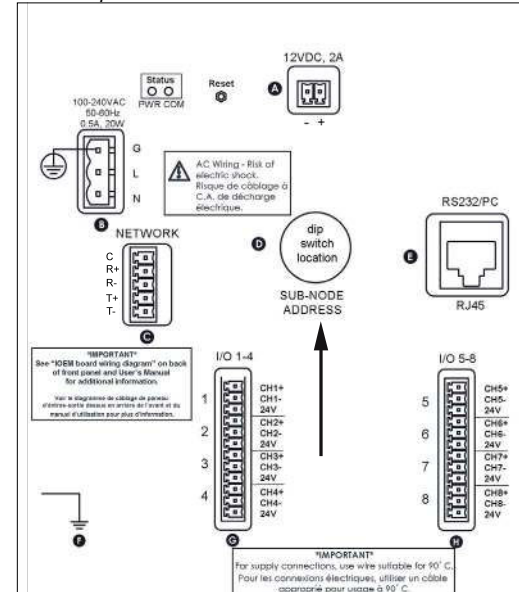

**"IMPORTANT"**  
For supply connections, use wire suitable for 90° C.  
Pour les connexions électriques, utiliser un câble approprié pour usage à 90° C.

REM dip switch location

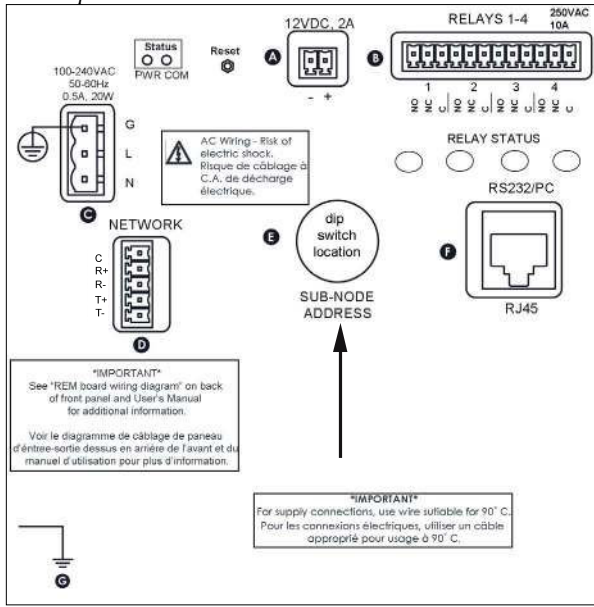

8. Configure dip switch at **D** IOEM **E** REM to set slave addresses and termination switch. Use a small flat head screw driver to set the dip switches.
  - A. The first 6 locations set the slave address bit. Use binary notation to set the dip switch slave address. Binary notation means switch 1=1, switch 2=2, switch 3=4, switch 4=8 and switch 5=16. (Dip switches 6 and 7 are not used.) Due to the orientation of the dip switch component on the board, number “1” is the far right switch. “On” is when the dip switch is in the **up** position when viewing with front panel open as shown on wiring diagrams throughout this user’s manual. Examples of 1-31 slave address settings and termination are below.
  - B. Dip switch 8 (far left) is the network termination switch. Set dip switch location 8 “on/up” when IOEM/REM device is the last slave on the network. Set dip switch 8 to “off/down” when IOEM/REM device is not the last slave on the network.

Dip Switch configuration table for slave addresses (1-31) and network termination

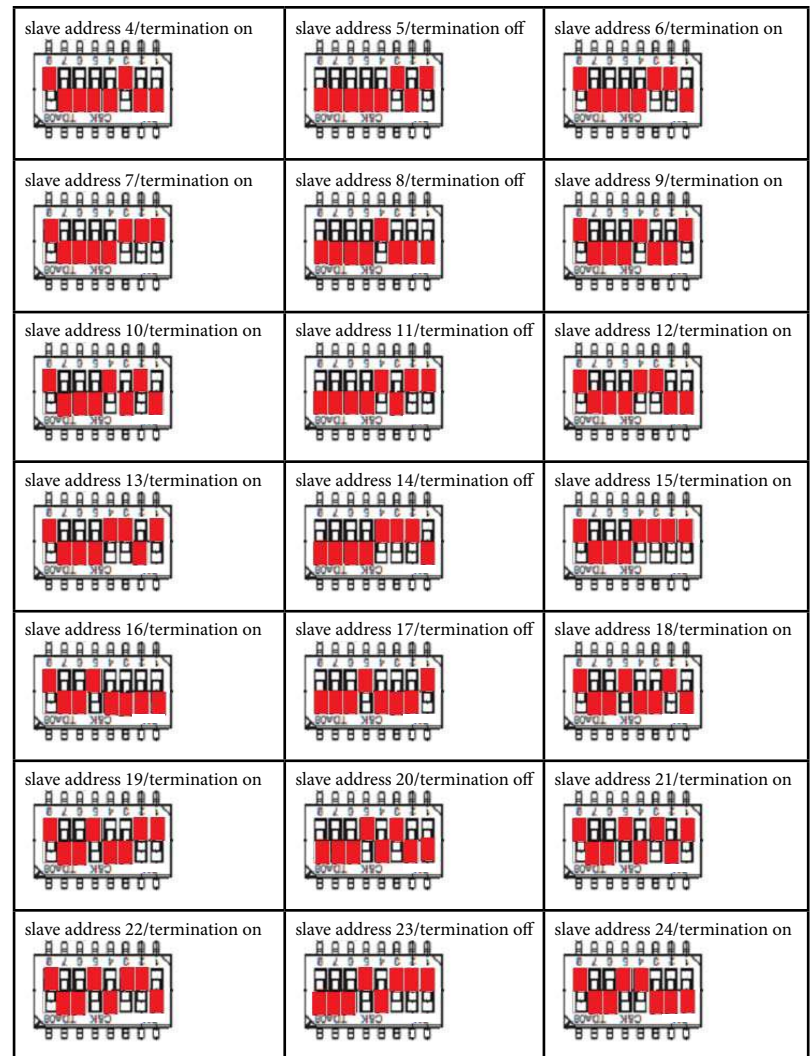
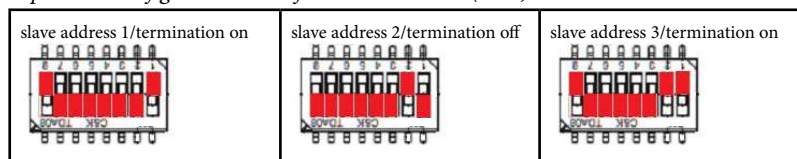

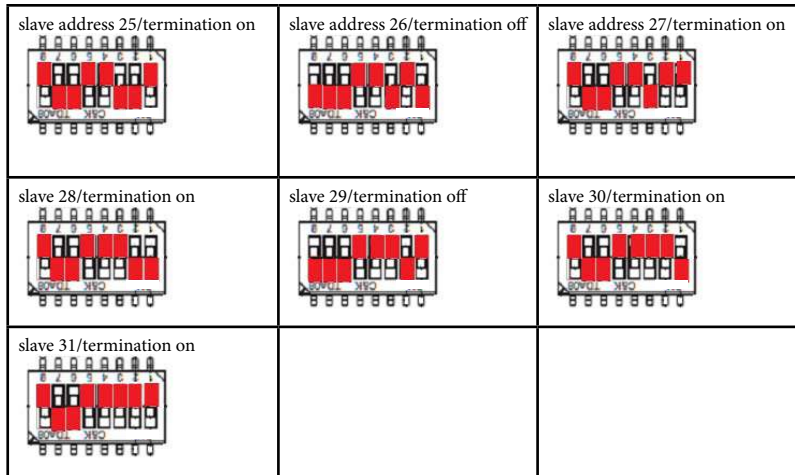

- Close front panel - page 32.
- Test network connections. Apply power to only the master and last slave device on the network. If the master is not the first physical device on the network, apply power to the master and the first and last physical slave devices on the network. See configure network menu in 5X00 user manuals for testing procedure. Slave devices need to be tested one by one as they are added to the network.

## Step 7 Connect Communication Cable for Firmware Update

An RS232 communication cable must be connected locally at the expansion module to a PC running AquaManager in order to upload new IOEM and REM firmware. Firmware is uploaded to IOEM and REM instruments using AquaManager. See Updating Instrument Firmware at AquaManager help or follow the steps below to upload new IOEM/REM firmware.

Note:

- When making RS232 cable runs greater than 100 feet (30.5 m), use an RS232 Line Extender/Booster. Mount the booster in an area where it is protected from moisture.

## RS232 Communication

Use Category 5e patch cable from RS232 port at location **E** IOEM and **F** REM RS232 Communication. Use an RJ45 to DB9 adapter to connect cable to PC 9 pin com port.

### IOEM com port

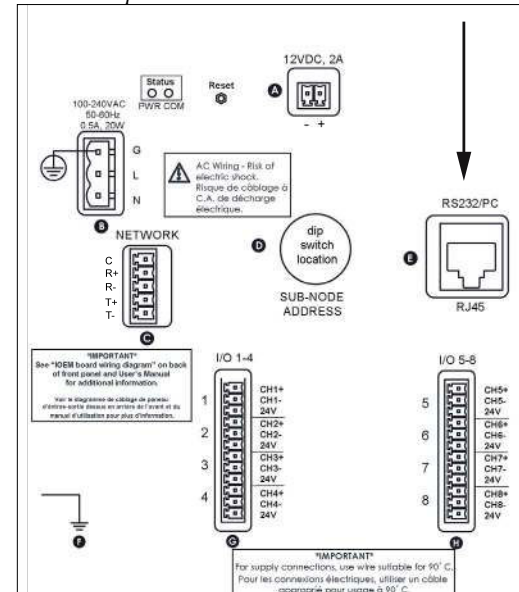

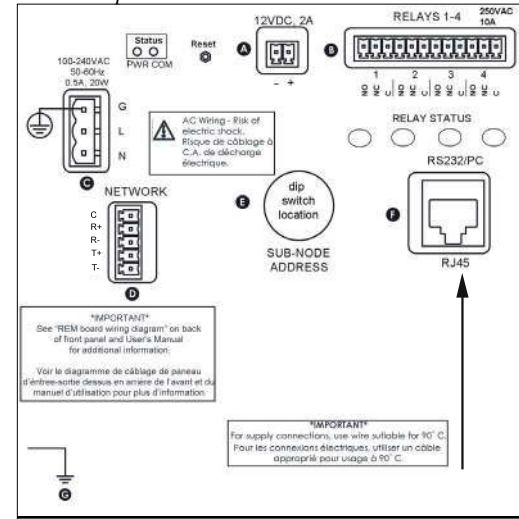

### REM com port



### Directions to Wire Direct PC Connection for firmware update

Like all microprocessor based instruments, it may be necessary to upload firmware revisions to IOEM/REM instruments. Download new firmware using the Firmware Updater utility in AquaManager. A serial RS232 connection is necessary to run the Flash Programmer utility.

 **WARNING:** Disconnect external power to the unit before wiring.

 **AVERTISSEMENT :** déconnectez l'alimentation externe de l'unité avant d'effectuer un câblage quelconque.

1. Perform steps 1- 6 of IOEM and REM installation as required for the application;
2. Open front panel - page 32;
3. With front panel open connect RS232 direct connect cable to location **E** IOEM and **F** REM. RS232 cable is disconnected after firmware update, so with wiring removed, after firmware update, RS232 communication cable does not interfere with front panel closure.

**Notes:**

- When using a USB-Serial Adapter, verify that the port number assigned during driver installation is the same port configured at AquaManager Firmware Updater utility.
  - Use only a Tripp-Lite Keyspan USB-Serial Adapter, model USA-19HS YSI p/n 773 (64-bit).
  - The instrument firmware may get corrupted if any of the following occurs during a firmware update: a) Firmware Updater window utility is closed, b) AquaManager is closed c) RS232 cable is removed from IOEM/REM or PC com port, d) power is disconnected from IOEM/REM. If IOEM/REM firmware becomes corrupt and is not updated properly, it may be necessary to return the instrument to YSI.
4. Confirm latest version of AquaManager is installed on PC - page 81. When an AquaManager patch has been installed and if new firmware is available, a "Firmware Update is Available" message is displayed when the IOEM/REM Systems Management expanded window is open at AquaManager.

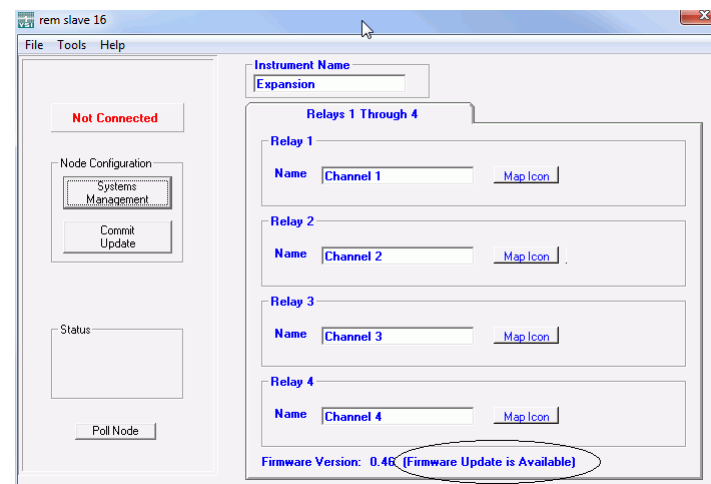

5. Upload new firmware using AquaManager. From the AquaManager Explorer window, access the Flash Programmer utility from AquaManager pull down menu: Tools→ Instrument tools→Update Firmware. Firmware updater window opens.

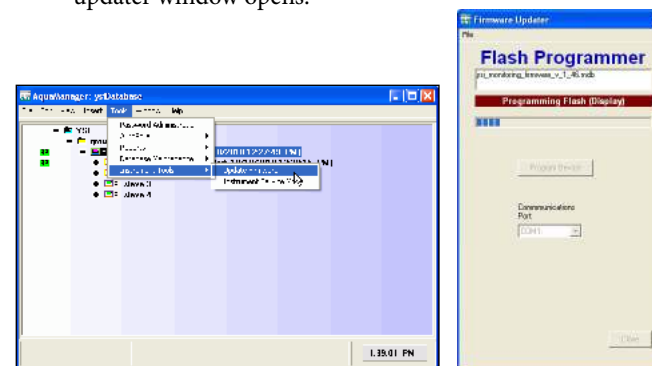

6. At Firmware Updater window File>Load Firmware Database default database firmware folder opens. Select latest firmware .mdb file to be uploaded to instrument(s). Once selected, Database file is displayed at File window.

**Notes:**

- Firmware Database file contains latest 5X00 and IOEM/REM instrument firmware. 5X00 and IOEM/REM instruments automatically upload proper firmware for specific instrument type;
- YSI .mdb firmware files are located in Program Files (folder where AquaManager is installed on user PC)>AquaManager>Firmware folder.

- The same .mdb file is used for all 5X00 and IOEM/REM instruments. Once the upload process begins the instrument type is determined and the appropriate firmware is uploaded.

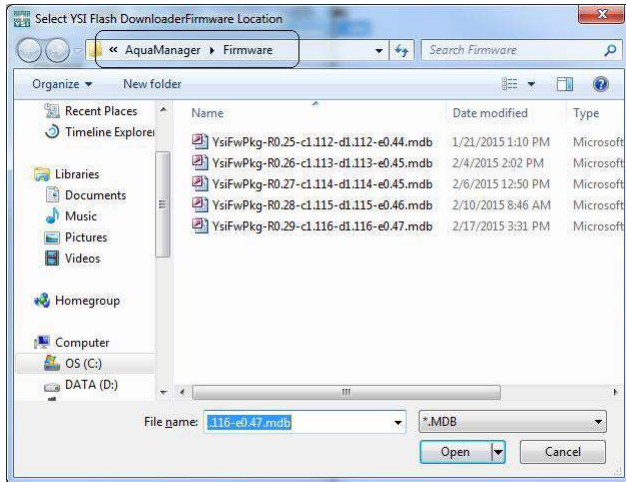

7. **Program Device** at Firmware Updater window. Firmware Update info window opens;

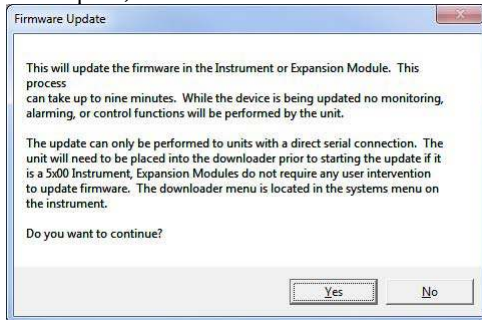

8. Left click "Yes" to begin firmware upload. Firmware Updater screen opens;

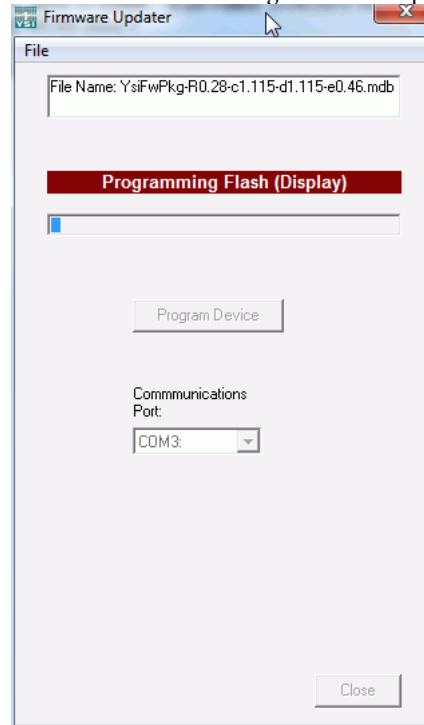

9. **Ok** at **YSI Flash Downloader 5200A/5400** window when upload completes;



10. Verify uploaded version information is correct at IOEM/REM node after manually polling IOEM/REM instruments. When all instruments have been uploaded with new firmware, it is important to open and poll all nodes to ensure latest firmware version is stored at AquaManager database. After manual poll, it may be necessary to close node window at AquaManager and reopen in order for latest firmware version to be displayed at node window.



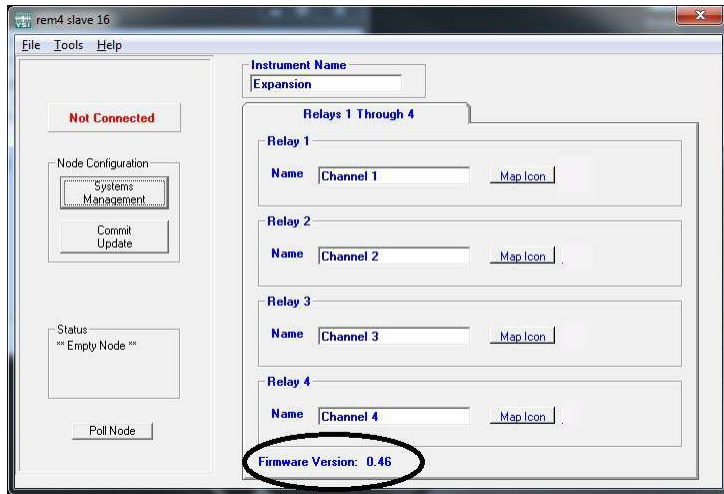

Notes:

- During upload, any active IOEM/REM devices are placed into Service Hold which de-energizes any active systems including energized relays. See *SVR Hold Menu* in 5X00 user’s manuals for additional information .
- No “off” event is created for IOEM/REM channels that are placed in Service Hold during firmware update process.
- Systems are reset when power is cycled after downloader;
- IOEM/REM total download time is < 1 minutes. IOEM/REM module will automatically reboot at firmware upload completion;
- Autopoll must be shut down when firmware is uploaded to 5X00;
- All logs and unit configuration are retained when 5X00 firmware is updated.
- Firmware Updater information is also included in AquaManager Help>Firmware Updater>Updating Instrument Firmware topic page.

**Flash Programmer Updater Messages**

The Firmware Updater program may respond with one of the following messages to indicate that the upload did not occur.

“Timed out” or “Could not find Unit” messages usually indicate a communication problem between PC and expansion module. Reconfirm AquaManager Firmware Updater com port setting and RS232 connections. Power cycle the instrument, close and reopen AquaManager and perform upload firmware steps again to see if communication problem is resolved.

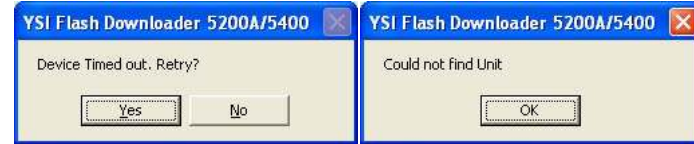

“Unit is Up-To-Date” indicates that the expansion module has most recent firmware and upload is not necessary.



11. Remove RS232 communication cable.
12. Close front panel - page 32.

**Lightning and Surge Protection**

AC line voltage surge suppressors protect field equipment on any AC line-to-ground from damage due to electrical transients induced in the interconnecting power lines from lightning discharges and other high voltage surges. Surge protection devices are strongly recommended to protect your equipment from secondary surges and lightning on outdoor installations. Follow the recommendations provided when choosing and incorporating surge protection devices into your operation:

**Recommendations:**

- Surge suppression devices should be located on the AC line supplying power to the IOEM and REM and any signal lines connecting the IOEM and REM.
- The unit should include noise filtering, common mode, and normal mode suppression and nanosecond reaction time.
- Surge suppressors should be internally-fused to remove the load if the unit is overloaded or the internal protection fails.
- Signal line suppressors protect low voltage signals and relay outputs from damage due to electrical transients induced in the signal lines from lightning discharges or nearby electrical devices.
- Signal line suppressors should be installed at each end of an analog loop.
- Relay outputs should be protected at the receiver end.

- Signal line suppressors should consist of a three-element gas tube followed by metal oxide varistors and suppressor diodes.
- The protective elements should be matched such that high-energy surge voltages trigger the gas surge arrester, while low energy or surge voltages affect the MOV's and suppressor diodes.
- Lightning protection devices should be located as close to the IOEM and REM as possible and wired in accordance with the National Electric Code in approved watertight enclosures.

 CAUTION: This or any other installation procedure cannot protect against a direct lightning strike. YSI Incorporated cannot accept liability for damage due to lightning or secondary surges.

## Sealants, Desiccants, and Securing IOEM and REM

Environmental conditions can promote the formation of condensation in and around the IOEM and REM. It is very important to follow the steps below to prevent damage to the electronic components and to extend the life of the IOEM and REM system.

1. Place solid rubber grommets in bulkhead fittings that have no electrical connections.
2. If using optional conduit fittings (YSI p/n 065926UL) in place of bulkhead fittings, industrial encapsulant (YSI p/n 065921 conduit sealer) must be used to prevent moisture from entering the IOEM and REM enclosure. Apply the sealant after all wiring and connections are complete. Failure to use industrial encapsulant may result in damage to the IOEM and REM.
3. Desiccant pack must be replaced whenever the IOEM and REM enclosure is opened (Desiccant pack, YSI p/n 006506). Desiccant absorbs moisture captured within the enclosure.
4. Ensure that the rubber gasket is seated between front panel and enclosure whenever enclosure is closed.
5. Replace the front panel ensuring that the ribbon cable is not trapped in the gasket channel before inserting mounting screws.
6. Tighten mounting screws, making sure not to cross thread. The screws are stainless steel and the receiving threads are brass. Do not over-tighten!

 CAUTION: The IOEM and REM utilizes sensitive solid state devices that can be damaged by static shock. Installers must observe accepted ESD (Electro-Static Discharge) procedures while connecting wires to the IOEM and REM control board.

 ATTENTION : les modèles d'IOEM (module d'expansion d'entrée et de sortie) et de REM (module d'expansion de relais) utilisent des appareils transistorisés sensibles pouvant être endommagés par des décharges d'électricité statique. Les installateurs doivent observer les procédures de protection acceptées contre les décharges électrostatiques lors du câblage à la carte de l'IOEM et du REM.

---

This page left intentionally blank.

## **4**

### **Using AquaManager to configure IOEM and REM Channels**

---

## IOEM and REM Configuration and Monitoring

IOEM and REM expansion modules do not have a user interface, meaning no configuration other than hardware wiring (page 43 IOEM and page 40 REM) and slave address configuration (page 55) are done locally at expansion modules. **AquaManager is required to upload IOEM mode configuration to the instrument. In addition, AquaManager must be used to upload all sensor setup>sensor system>output 4/20mA menus which menus include configuration of IOEM slave and channel to be used for a sensor system output. AquaManager includes software checks that help to validate IOEM 4/20mA output assignment configuration.** Directions to configure these menus using AquaManager are provided at the Quick Start - IOEM Configuration starting on page 72.

At AquaManager polls, a network query occurs to determine whether configuration changes have been made to any networked instruments. When configuration changes are detected during an AquaManager manual poll, AquaManager updates the database to ensure the AquaManager database is in sync with networked instruments. Example - if a manual poll is performed on a networked master 5200A, all instruments on the network are queried. If, on this network, a change was made locally to a slave 5500OD, the local change made to the slave 5500OD is updated to AquaManager. This process allows the database to be up to date with the instruments at all times. **It is critical that the instruments be polled at frequent time intervals to ensure AquaManager is in sync with actual instrument configuration.**

Note:

- Manual polls are required to update AquaManager firmware updates. Autopolls do not update firmware installation version information. See verify latest firmware version after using Firmware Updater - step 10, page 63

Quick start guide instructions are provided for IOEM I/O - page 72 and REM - page 80.

Use 5X00 instrument user manuals for information regarding Run Screen, Sensor and System set up menu configuration. To Access pdf interactive manuals in AquaManager at the Explorer Window Help>Instrument Manuals>scroll and select instrument manual to open interactive pdf file. Configuration of IOEM input, 4/20mA, PID control output and REM relay system configuration are provided at sensor setup section in chapter 4 of 5X00 user manuals. Configuration of System Menu items (such as general alarm relay) are provided at system menu>appropriate system section in chapter 4. Configuration of Timer relays are provided at Timers Menu section in chapter 4. Manuals are also accessible at <http://ysi.com/resource-library.php>.

## IOEM/REM terminology

Below is a list of common terminology used to describe IOEM and REM devices as well as IOEM, REM and 5X00 EauX system functionality:

**I/O**-An IOEM instrument is an I/O device whose channels are wired and configured using the IOEM expansion module. “I”= input. Configure an IOEM channel to be an input when the incoming signal is used to track a temperature, 0-1v, 0-5v, 4/20mA, or digital device. “O” = output. Configure an IOEM channel to be a 4/20mA output when a 5X00 system input signal is to be converted to a 4/20mA output signal which can be used by another connected device such as a PLC. 4mA-20mA outputs can also be used as a 5X00 system PID control device.

**Channel**-refers to the physical 1 through 4 (IOEM4) and 1 through 8 (IOEM8) I/Os. I/O devices are wired to terminal strips located on the IOEM expansion module see page 43; **Channel** also refers to the physical 1 through 4 relay outputs wired to terminal strip locations 1-4 on the REM expansion module - page 40.

**E-Aux Systems**-5X00 instruments have eight (8) E-Aux systems. E-Aux systems are configured to monitor, control and/or alarm IOEM inputs the same way 5X00 sensor systems function. E-Aux systems have data and event logging functionality. E-Aux systems are also referred to as “virtual systems.”

**E-Aux system datalogs**-5X00 E-Aux system datalogs are not visible at the instrument. AquaManager datalogs must be used to view E-Aux system datalogs;

**Local vs Remote Instruments**-A **local** instrument on a 5X00 network is defined as a 5X00 instrument that is using it's own relay output as a sensor or system control or alarm. So, for example if a 5200A's (s/n 53-1111111) pH control or alarm system is configured to use it's own (5200A s/n 53-1111111) relay 1 to control for low pH, the relay assignment is considered a **local** relay configuration. If this same 5200A's (s/n 53-1111111) pH control or alarm system is configured to use a networked 5500 (s/n 55-2222222) relay 1, the relay configuration is considered a **remote** relay configuration. IOEM input and IOEM and REM output channels are always considered to be remote configurations because expansion modules input and output devices are always configured to a networked 5X00 instrument system. Knowing the difference between local and remote instruments is important since certain menus like 5X00 system and sensor setup menus display local versus remote instrument names differently.

**Instrument and Relay name conventions at 5X00 instrument menus** - Configured instrument and relay names are displayed differently at a 5X00 instrument when local versus remote instruments are selected at configuration menus. For example, at sensor setup>sensor selection>control/alarm system>Instrument window, the instrument window displays a generic list of instruments being Local Machine, Master and Slaves 1-31. The Local Machine user configured name is displayed if the local machine is configured. A relay is selected at the sensor or system>relay menu.

The relay window displays a generic list of relays being relays 1-8 regardless if a local relay has a user configured name. Remote 5200A or REM instruments always display relays 1-8 even though these instruments have only 4 relays.

**Mode**-refers to the input or output configuration of an IOEM channel. Selectable Input modes are: digital, 0-1V, 0-5 V, 4/20mA and temperature. There is one output mode and it is 4/20mA. **IOEM channel mode can only be configured using AquaManager.** IOEM modes are configured in AquaManager at the IOEM node>Systems Management>Channel Mode pulldown menu;

**5X00 systems**-refers to any 5X00 sensor system. 5200A systems are pH, ORP, conductivity, temperature, DO, Aux and E-Aux. 5400 and 5500 sensor systems are DO, Aux and E-Aux.

**Source**-refers to the IOEM device slave address and channel number that a particular Eaux system will use as its input. The IOEM source is configured in AquaManager at the E-Aux 1-8 tabs. IOEM inputs can be used by multiple E-Aux systems.

**Virtual system**-5X00 E-Aux systems are referred to as virtual systems because of their ability to be used for a variety of device configurations.

AquaManager provides data logging, graphing, autopolling, mapping and system configuration uploading functionality. AquaManager also displays near real-time sensor, aux and E-Aux input values at the desktop PC. AquaManager is a valuable tool for remote and local access applications.

Use AquaManager to configure IOEM and REM system menus. After polling all instruments on a network, use node window “Systems Management” to view and upload IOEM and REM configurations.

Detailed AquaManager user information is included in the AquaManager Help system.

*The IOEM and REM Quick Starts guides below assumes a user has a general knowledge of AquaManager Explorer and Systems Management Windows.*

## Quick Start - IOEM Configuration

IOEM instruments have either 4 I/O channels (IOEM-4) or 8 I/O channels (IOEM-8). IOEM channels can be configured one of three (3) modes. Each mode is described below:

1) **Input mode** - IOEM channels can be configured as an input. Input mode selections are digital, 0-1 Volt, 0-5Volt, 4/20mA and temperature. IOEM inputs use one of the 5X00 instrument’s eaux systems. (Each 5X00 instrument has 8 Eaux systems. Eaux systems are also referred to as virtual systems.) 5X00 Eaux systems are configured to monitor, control and/or alarm IOEM inputs the same way 5X00 sensor systems

function. Eaux systems also have datalogging and event logging functionality.

2) **4/20mA output mode** - IOEM channels can be configured as a 4/20mA output. The 4/20mA output can be used for any 5X00 sensor (pH, ORP, conductivity, temperature, DO), aux and eaux (analog, digital, temperature) system. The 4/20mA output signal can be used by another connected device such as a PLC.



3) **PID control output device mode** - 4/20mA IOEM output channels can be configured for a PID control output device for 5X00 sensor (pH, ORP, conductivity, temperature, DO) and aux and eaux non digital systems. PID control devices, such as a valve, would open and close at user configured setpoints to maintain system values.

Notes:

- **IOEM mode must be configured using AquaManager.**
- 5X00 system must be configured in the PID 4/20mA control mode for PID control output device mode option to be available.

Configuration of the IOEM mode is done at the IOEM node>Systems Management window>Channel Mode pulldown menu. Full configuration directions and functionality are provided in AquaManager help.

## Use AquaManager to configure IOEM channel mode

1. Verify latest AquaManager version is installed - page 81;
2. Build AquaManager Network. At AquaManager Help>Contents tab>Working with nodes>Communication>Insert Node with direct connection or Insert Node with IP connection>Insert Slave device help topic bookmark for information.
3.  for all networked nodes including IOEM node(s).
4. Verify latest IOEM/REM firmware is installed - page 60;
5. Configure IOEM I/O mode at the IOEM node systems management window. At AquaManager Help>Contents tab>Working with nodes>Expansion modules>IOEM>Configure IOEM mode help topic bookmark for information.
6.  to upload IOEM I/O channel mode configuration to network.

**IOEM systems management window mode pulldown menu**

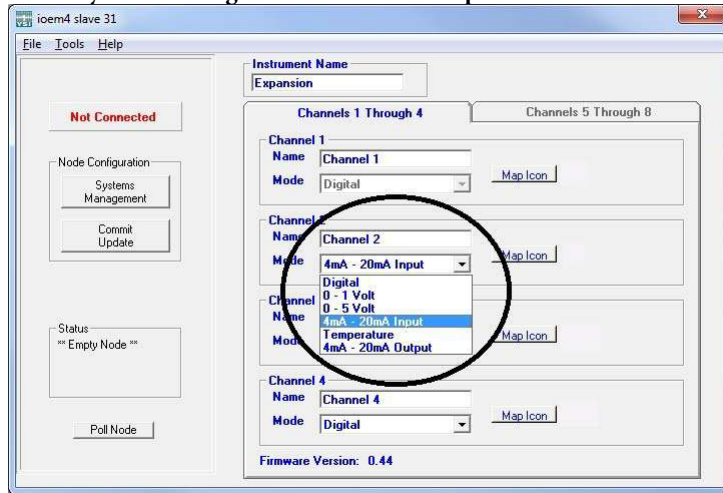

**Configure 5X00 E-Aux system for IOEM input**

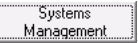
1. Follow steps 1-6 of hardware installation-starting on page 25;
2. Wire IOEM I/O for desired input type- page 43;
3. Verify all steps at Using AquaManager for IOEM configuration - page 73 are completed
4. Open AquaManager>open 5X00 node window> ;
5. Select E-Aux 1-8 tab to be configured.
6. Configure E-Aux system fields;

Notes:

- IOEM Source channels are only available once IOEM mode has been uploaded using AquaManager-page 73;
- IOEM Sources will only be available at IOEM and channel mode pulldown menus that have been configured as the same input type as the “IOEM Desired Selection” field for the E-Aux system being configured;
- Proper wiring of IOEM I/O channels is required in order for IOEM I/O channels to work correctly.
- For 5X00 E-Aux configuration information see - AquaManager Help>Contents tab>Working with Nodes>Systems management>Systems Management fields table and link to E-Aux bookmarks;

7.  to upload E-Aux system configuration to networked instruments;

8. At the Run Screen verify the configured E-Aux value is properly displayed. E-Aux system scaling and min/max configuration affect the displayed value.

**5X00 Systems Management Eaux tab non PID control mode**

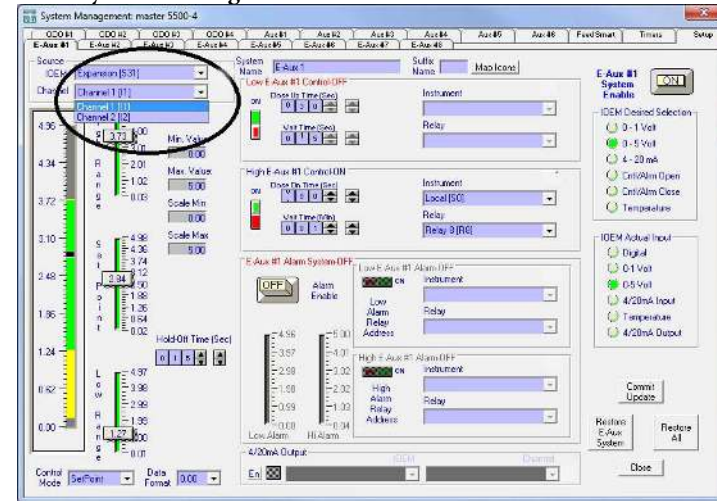

Notes:

- IOEM input channels can be configured to multiple E-Aux systems;
- At the Run Screen “Offline” display means the configured IOEM I/O input/output is a value that the associated 5X00 instrument E-Aux system does not recognize. An example - if an IOEM channel mode is configured to digital and the input signal is a 0-1V signal, the reading at the run screen will be “Offline”;

**5X00 instrument run screen when IOEM input value is invalid**

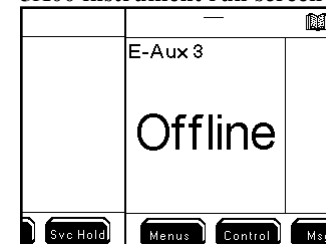

- At the instrument, the IOEM source is configured at the System>E-Aux>Device Address and Channel menus. See user manual sensor setup sections, chapter 4 for additional information;

**Configure 5X00 system for IOEM 4/20mA output**

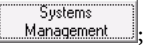
1. Follow steps 1-6 of hardware installation-starting on page 25;
2. Wire IOEM I/O for 4/20 output type- page 47;
3. Verify all steps at Using AquaManager for IOEM configuration - page 73 are completed;
4. Open AquaManager>open 5X00 node window> ;
5. Select 5X00 system tab to be configured;
6. Configure 5X00 4/20mA output system fields;

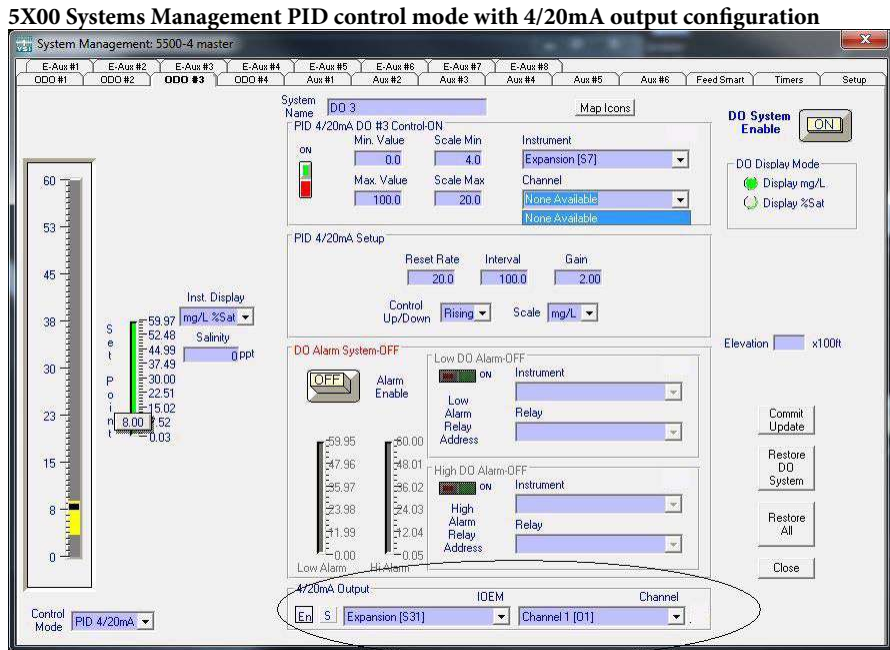

**Notes:**

-  must be selected to make 4/20mA fields live;
- Proper wiring of IOEM output channel is required in order for IOEM 4/20mA output device to work correctly.
- IOEM Source channels are only available at 5X00 system fields once IOEM mode has been uploaded using AquaManager-page 73;
- IOEM Sources will only be available at IOEM and channel mode pull-down menus that have been configured as a 4/20mA output type; For 5X00 system configuration field information see - AquaManager Help>Contents tab>Working with Nodes>Systems management>Systems Management fields table and link to specific sensor system being configured bookmarks;

- 4/20mA output channels can only be assigned to 1 5X00 system at a time. When selecting a 4/20mA output channel that is currently pending or confirmed AquaManager displays the below 4/20mA Conflict Error window.  will not be live until the 4/20mA assignment conflict is resolved
- 4/20mA output values cannot be viewed at 5X00 instruments or at AquaManager.

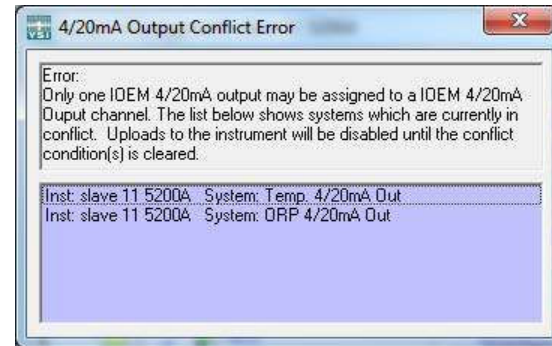

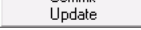
7.  to upload system configuration to networked instrument;
8. Test configured output functionality after reconfiguring - see Chapter 4 5X00 instrument manuals Configuring>Sensor Setup>Service> Output test system menu to verify 4/20mA output.
9. Verify 4/20mA signal. The 4/20mA output signal is not displayed at the Run Screen. Therefore, it is strongly recommended to verify the 4/20mA signal at the IOEM or third party device.

**Configure 5X00 system for IOEM PID output control device**

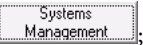
1. Follow steps 1-6 of hardware installation-starting on page 25;
2. Wire IOEM I/O for 4mA-20mA output type- page 47;
3. Verify all steps at Using AquaManager for IOEM configuration - page 73 are completed;
4. Open AquaManager>open 5X00 node window> ;
5. Select 5X00 system tab to be configured;
6. Configure 5X00 system fields
  - For 5X00 system configuration field information see - AquaManager Help>Contents tab>Working with Nodes>Systems management>Systems Management fields table and link to specific sensor system being configured bookmarks;

5X00 Systems Management PID control mode with 4/20mA PID output control device

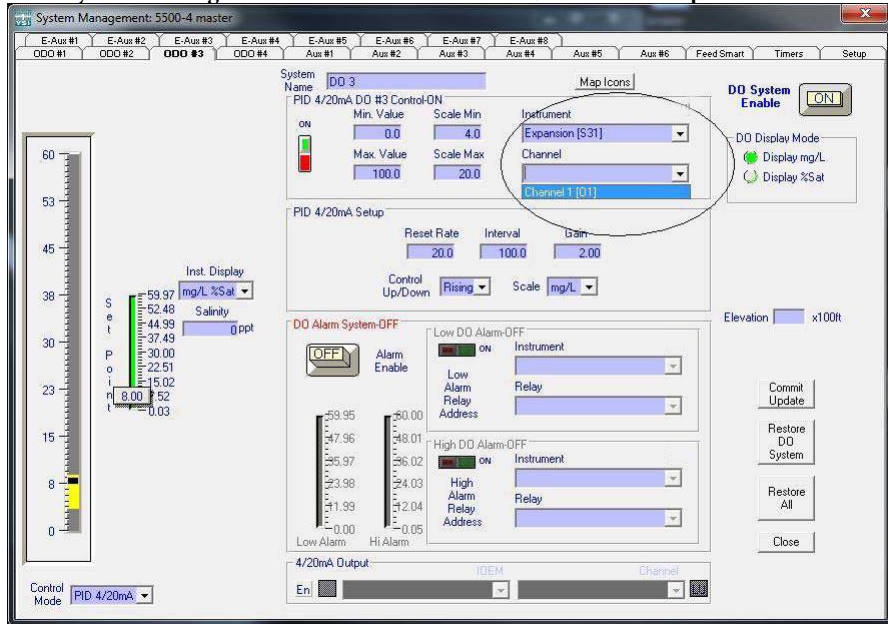

Notes:

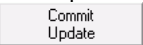
- Proper wiring of IOEM output channel is required in order for IOEM 4ma-20mA output control device to work correctly.
- IOEM Source channels are only available at 5X00 system fields once IOEM mode has been uploaded using AquaManager-page 73;
- IOEM Sources will only be available at IOEM and channel mode pull-down menus that have been configured as a 4/20mA output type;
- For 5X00 system configuration field information see - AquaManager Help>Contents tab>Working with Nodes>Systems management>Systems Management fields table and link to specific sensor system being configured bookmarks;
- **4/20mA output channels can only be assigned to 1 5X00 system at a time.** When selecting a 4/20mA output channel that is currently pending or confirmed AquaManager displays the below 4/20mA Conflict Error window.  will not be live until the 4/20mA assignment conflict is resolved.

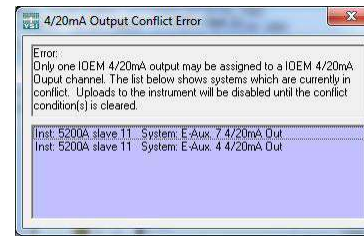

-  icon will be displayed at the Run Screen for systems configured with a PID output control device.

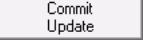
7.  to upload system configuration to networked instrument;
8. Verify wired 4/20mA output device is regulating the system correctly based on the system value.

Reset IOEM to factory

Follow the steps below to reset an IOEM expansion module back to factory settings. A factory reset will return all IOEM channels to the default mode of 0-1V input. All 5X00 instrument systems that were configured using IOEM inputs and outputs need to be reconfigured. Reset of IOEM to factory also restores IOEM instrument and channel names to default names.

1. Open front panel - page 32;
2. Press Reset button for about 10 - 11 seconds. The reset button is located to the left of the DC power connection (located at location **A**) on the metal plate inside the enclosure. Observe that both status leds, as described at page 85, display solid green at the same time before releasing the reset button. Some clicking at board may be heard as all channels are reset to 0-1V inputs. Leds return to normal operation (page 85) several seconds after reset.
3. Close front panel -page 32.
4. Manually poll all nodes at AquaManager to ensure the AquaManager database is properly updated to reset configurations.
5. Reconfigure IOEM input/output modes - see page 73;
6. Reconfigure 5X00 systems IOEM inputs and outputs after polling all nodes at AquaManager;
7. Test configured input and output functionality after reconfiguring.



## Quick Start - REM Configuration

An REM has 4 relay outputs. REM relays are available at all 5X00 instrument menus including sensor, aux, E-Aux, Timer and system menus.

### Use AquaManager to configure REM

1. Verify latest AquaManager version is installed - page 81;
2. Build AquaManager Network;

Note:

- At AquaManager Help>Contents tab> Working with nodes>Insert Node with direct connection or Insert Node with IP connection>Insert Slave device help topic bookmark for information.
3.  for all networked nodes including REM node(s).
  4. Verify latest REM firmware is installed - page 60;
  5. Configure REM node systems management window.
  6.  to upload REM configuration to AquaManager network.

### REM systems management window

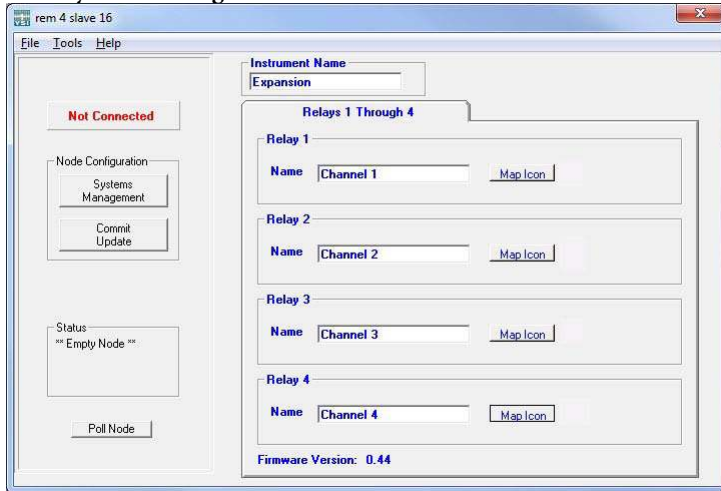

### Configure REM relay(s) to 5X00 system(s)

1. Follow steps 1-6 of hardware installation-starting on page 25;
2. Wire REM relays - page 40;
3. Verify all steps at Use AquaManager to configure REM - page 80 are completed;
4. Open AquaManager>open 5X00 node window> ;

5. Select 5X00 system tab to be configured;
6. Configure 5X00 system fields.

Notes:

- At AquaManager Help>Contents tab>Working with nodes>Expansion modules>REM>Configure REM relay to a 5X00 system bookmark for information;
7.  to upload system configuration to networked instrument;
  8. Test configured relay output functionality after reconfiguring - see *Chapter 4 5X00 instrument manuals Configuring>Sensor Setup>Service> Output test system menu to verify 4/20mA output.*

Notes:

- At Run Screen 5X00 instrument system using REM relay will show control and or alarm relay icons when REM system relay is energized;
- REM relay events are stored at the 5X00 instrument using the relay;
- REM channels can be assigned to multiple system;

### Reset REM to factory

Follow the steps below to reset an REM expansion board back to factory settings. A factory reset will return all REM channels to the default instrument and channel names. It is important that AquaManager poll all nodes after any instrument on a network is reset to factory.

1. Open front panel - page 32
2. Press Reset button for about 10 seconds. The reset button located to the left of the DC power connection (located at location **A**) on the metal plate inside the enclosure. Observe that both status leds, as described at page 85, display solid green at the same time before releasing the reset button
3. Close front panel -page 32.
4. Poll all nodes at AquaManager to ensure the AquaManager database is properly updated to reset configurations.
5. Reconfigure 5X00 system REM outputs after polling all nodes at AquaManager.
6. Test configured output functionality after reconfiguring.

### Confirm latest AquaManager version is installed on PC

For proper AquaManager functionality it is important that the latest AquaManager version be installed on your PC. Comprehensive information is provided in AquaManager Help>Contents tab>Getting Started>System Requirements>Update AquaManager Software for version information.

If an AquaManager patch is available the user will be notified at AquaManager program launch. Because many AquaManager users run Autopoll 24/7 a new feature has been added to AquaManager to ensure the current AquaManager version is installed and running on the PC. A notification of any AquaManager patch update is sent every 30 days regardless of AquaManager program launch. This notification will be visible, if after 30 days, a new AquaManger version is available regardless of what AquaManager window is open.

# Appendices

---

- Appendix 1 - Unpacking and Inspection
- Appendix 2 - Troubleshooting
- Appendix 3 - Declaration of Conformity
- Appendix 4 - Alpha "A" curve
- Appendix 5 - Parts and Accessories
- Appendix 6 - Warranty
- Appendix 7 - Contact and Service Information
- Appendix 8 - Product Recycling

## Appendix 1 Unpacking and Inspection

Inspect the outside of the shipping carton for damage. If damage is detected, contact the carrier immediately. Remove the instrument from the shipping container. Be careful not to discard any parts or supplies. Confirm that all items on the packing list are present. Inspect all assemblies and components for damage. Save the original packing carton. Carriers typically require proof of damage due to mishandling.

The following components are included with the purchase of the IOEM and REM instrument:

IOEM and REM instrument  
 006515 Flange Mounting Kit  
 006506 Desiccant Kit  
 605876 Instruction Manual  
 605230 Compression Plugs, 2 each  
 605229 Compression Plugs, 2 each  
 605804 Compression Plugs, 1 each  
 655384 Dual Male RJ-45 Cable Assembly  
 655383 Adapter, DB-9 to RJ-45  
 605880 AC Power Cord, 115 VAC U.S. Plug (AC version only)  
 605944UL Pluggable Socket Connector for AC power, 3 pole (AC Version only)  
 506939UL Pluggable Socket Connector for 12 VDC Power, 2 pole  
 605941UL Pluggable Socket Connector for RS-485, 5 pole  
 605943UL Pluggable Socket Connector for relay, 12 pole  
 605940UL Pluggable Socket Connector for Auxiliary inputs, 3 pole

If any parts are damaged or missing, contact YSI or your YSI representative immediately.

## Appendix 2 Troubleshooting

### Status leds

There are 2 status leds located on IOEM and REM devices. The leds are located left



of the DC power connector location at **A** on IOEM and REM devices. The PWR status LED is illuminated solid green when 12v power is applied. The COM status LED has 3 states as described below:

1. OK (RS485 communications active)
  - A. Short (100mS) flash every second. This is the normal and most common state.
2. Communication error
  - A. Fast blinking (on 200mS/off 200mS)
3. Bootloader, when firmware is being uploaded
  - A. Slow blinking (on 500mS/off 500mS)

See IOEM reset to factory - page

See REM reset to factory - page

### Relay (Outputs) Troubleshooting

- Disable control, alarm, and timer relays when troubleshooting relay outputs.
- Verify IOEM and REM wiring and configuration.

Issue	possible cause	possible solution
relay does not energize	incorrect sensor configuration	See <i>Set Points, Controls, and Alarm</i> , 5X00 instrument user manuals. is correct relay configured?
	incorrect timer configuration	See <i>Timers</i> , 5X00 instrument user manuals.
	30 second delay at power up and/or sensor configuration change	See <i>30 seconds delay</i> , 5X00 instrument user manuals.
	peripheral device is wired incorrectly	See <i>Wire Relays</i> - page 40 and <i>Test Relays</i> - page 34.

## Troubleshooting

Issue	possible cause	possible solution
	relays are not enabled for control/alarm/timer system	Verify menu configuration- See <i>Set Points, Controls, and Alarm&gt;relay enable menus and Timer System&gt;relay enable menus</i> , 5X00 instrument user manuals.
temp (high), pH, and or conductivity relays do not de-energize when set point values are read	sensor is configured for timed control	See <i>Set Points, Controls, and Alarm</i> , 5X00 instrument user manuals.

### Network Troubleshooting

Issue	possible cause	possible solution
no communication to networked unit(s)	Are master/slave menus properly configured?	See <i>Networking</i> - page 48.
	Is termination relay enabled in 1st & last IOEM and REM on network?	See <i>Termination Relay</i> - page 56.
	Are slaves enabled and recognized at master?	See <i>System → Communications → Network → Master menu</i> , 5X00 instrument user manuals.
	more than one device is configured as a master	See <i>System → Communications → Network → Master menu</i> , 5X00 instrument user manuals.
slow network performance	nicked wires; improper wiring	Verify network wiring - See <i>Wire Network</i> - page 48.

### Firmware Updater Troubleshooting

Issue	possible cause	possible solution
Device “timed out” error	incorrect wiring of RS232 connection	See <i>Connect RS232 Communication Cable</i> - page 58 .

## Troubleshooting

Issue	possible cause	possible solution
IOEM and REM does not go into downloader mode when “program device” is selected at Firmware Updater	incorrect wiring of RS232 connection	see “ <i>Status leds</i> ” on page 85 to confirm that expansion module is in downloader.
unit does not upload new code at downloader	unit is not in downloader mode	see “ <i>Status leds</i> ” on page 85 to confirm that expansion module is in downloader

### AquaManager Troubleshooting

Refer to AquaManager online Help for all AquaManager operation and troubleshooting information.

## Appendix 3 Declaration of Conformity

The undersigned hereby declares on behalf of the named manufacturer under our sole responsibility that the listed product conforms to the requirements for the listed European Council Directive(s) and carries the CE mark accordingly.

<i>Manufacturer:</i>	YSI Incorporated 1725 Brannum Lane Yellow Springs, OH 45387 USA
<i>Product Name:</i>	IOEM-4, IOEM-8, REM-4 Aquaculture Expansion Modules
<i>Model Numbers</i>	
<i>Instrument/Accessory:</i>	IOEM-4, IOEM-8, REM-4
<i>Conforms to the following:</i>	
<i>Directives:</i>	EMC 2004/108/EC RoHS 2011/65/EU WEEE 2002/96/EC LVD 2006/95/EC
<i>Harmonized Standards:</i>	<ul style="list-style-type: none"> <li>• EN61326-1:2012, Electrical equipment for measurement, control, and laboratory use – EMC requirements – Part 1: General Requirements</li> <li>• EN61000-3-2:2006+A1:2009+A2:2009 Electromagnetic compatibility (EMC) – Part 3-2: Limits – Limits for harmonic current emissions (equipment input current &lt; 16A per phase).</li> <li>• EN61000-3-3:2008, Electromagnetic compatibility (EMC) – Part 3-3: Limits – Limitation of voltage changes, voltage fluctuations and flicker in public low-voltage supply systems, for equipment with rated current &lt; 16A per phase and not subject to conditional connection..</li> <li>• IEC61010-1:2010 Safety requirements for electrical equipment for measurement, control, and laboratory use - Part 1: General requirements</li> </ul>

<i>Supplementary Information:</i>	All performance met the continuous unmonitored operation criteria as follows: <ul style="list-style-type: none"> <li>• ESD, EN61000-4-2:2009</li> <li>• Radiated Immunity, EN61000-4-3:2006+A1:2007+A2:2010</li> <li>• EFT, EN61000-4-4:2004+A1:2010</li> <li>• Surge, EN61000-4-5:2006</li> <li>• Conducted Immunity, EN61000-4-6:2009</li> <li>• Voltage Interrupts, EN61000-4-11:2004 2nd edition</li> </ul>
<i>Authorized EU Representative</i>	YSI Hydrodata Ltd Unit 8, Business Centre West, Avenue 1 Letchworth, Hertfordshire, SG6 2HB UK



Signed: Gregory Popp  
Title: Quality Manager

Date: 22 April, 2015

The undersigned hereby declares on behalf of the named manufacturer under our sole responsibility that the listed product conforms to the requirements for electrical equipment under US FCC Part 15 and ICES-003 for unintentional radiators.

<i>Manufacturer:</i>	YSI Incorporated 1725 Brannum Lane Yellow Springs, OH 45387 USA
<i>Product Name:</i>	IOEM-4, IOEM-8, REM-4 Aquaculture Expansion Modules
<i>Model Numbers</i>	
<i>Instrument/Accessory:</i>	IOEM-4, IOEM-8, REM-4
<i>Conforms to the following:</i>	
<i>Standards:</i>	<ul style="list-style-type: none"> <li>• FCC 47 CFR Part 15, Radio Frequency Devices</li> <li>• ICES-003:2012, Digital Apparatus</li> </ul>



Signed: Gregory Popp  
Title: Quality Manager

Date: 22 April, 2015

### FCC Required Notice

The Federal Communications Commission defines this product as a computing device and requires the following notice.

This equipment generates and uses radio frequency energy and if not installed and used properly, may cause interference to radio and television reception. It has been type tested and found to comply with the limits for a Class A or Class B computing device in accordance with the specification in Subpart J of Part 15 of FCC Rules, which are designed to provide reasonable protection against such interference in a residential installation. However, there is no guarantee that interference will not occur in a particular installation. If this equipment does cause interference to radio or television reception, which can be determined by turning the equipment off and on, the user is encouraged to try to correct the interference by one or more of the following measures:

- Reorient the receiving antenna
- Relocate the computer with respect to the receiver
- Move the computer away from the receiver
- Plug the computer into a different outlet so that the computer and receiver are on different branch circuits.

If necessary, the user should consult the dealer or an experienced radio/television technician for additional suggestions. The user may find the following booklet, prepared by the Federal Communications Commission, helpful: "How to Identify and Resolve Radio-TV Interference Problems". This booklet is available from the U.S. Government Printing Office, Washington, D.C. 20402, Stock No.0004-000-00345-4.

### Appendix 4 Alpha "A" curve

**ALPHA "A" CURVE**  
Resistance-Temperature Conversion Table

Temp °C	Resistance	Temp °C	Resistance	Temp °C	Resistance	Temp °C	Resistance
-40	336600.0000	8	21920.0000	56	2878.00000	104	605.000000
-39	315000.0000	9	20880.0000	57	2774.00000	105	588.000000
-38	295000.0000	10	19900.0000	58	2674.00000	106	571.400000
-37	276400.0000	11	18970.0000	59	2580.00000	107	555.600000
-36	259000.0000	12	18090.0000	60	2488.00000	108	540.200000
-35	242800.0000	13	17260.0000	61	2400.00000	109	525.200000
-34	227800.0000	14	16460.0000	62	2316.00000	110	510.800000
-33	213800.0000	15	15710.0000	63	2234.00000	111	496.800000
-32	200600.0000	16	15000.0000	64	2158.00000	112	483.200000
-31	188400.0000	17	14320.0000	65	2082.00000	113	470.200000
-30	177000.0000	18	13680.0000	66	2012.00000	114	457.400000
-29	166400.0000	19	13070.0000	67	1942.00000	115	445.200000
-28	156500.0000	20	12490.0000	68	1876.00000	116	433.400000
-27	147200.0000	21	11940.0000	69	1813.00000	117	421.800000
-26	138500.0000	22	11420.0000	70	1751.00000	118	410.600000
-25	130400.0000	23	10920.0000	71	1693.00000	119	399.800000
-24	122900.0000	24	10450.0000	72	1637.00000	120	389.400000
-23	115800.0000	25	10000.0000	73	1582.00000	121	379.200000
-22	109100.0000	26	9574.00000	74	1530.00000	122	369.400000
-21	102900.0000	27	9166.00000	75	1480.00000	123	359.800000
-20	97120.0000	28	8778.00000	76	1432.00000	124	350.600000
-19	91660.0000	29	8408.00000	77	1385.00000	125	341.600000
-18	86540.0000	30	8058.00000	78	1341.00000	126	332.800000
-17	81720.0000	31	7722.00000	79	1298.00000	127	324.400000
-16	77220.0000	32	7404.00000	80	1256.00000	128	316.200000
-15	72980.0000	33	7098.00000	81	1216.00000	129	308.200000
-14	69000.0000	34	6808.00000	82	1178.00000	130	300.600000
-13	65260.0000	35	6532.00000	83	1141.00000	131	293.000000
-12	61760.0000	36	6268.00000	84	1105.00000	132	285.800000
-11	58460.0000	37	6016.00000	85	1071.00000	133	278.800000
-10	55340.0000	38	5776.00000	86	1038.00000	134	272.000000
-9	52420.0000	39	5546.00000	87	1006.00000	135	265.200000
-8	49660.0000	40	5326.00000	88	975.000000	136	258.800000
-7	47080.0000	41	5118.00000	89	945.200000	137	252.600000
-6	44640.0000	42	4918.00000	90	916.400000	138	246.400000
-5	42340.0000	43	4726.00000	91	888.800000	139	240.600000
-4	40160.0000	44	4544.00000	92	862.000000	140	234.800000
-3	38120.0000	45	4368.00000	93	836.400000	141	229.200000
-2	36200.0000	46	4202.00000	94	811.400000	142	223.800000
-1	34380.0000	47	4042.00000	95	787.400000	143	218.400000
0	32660.0000	48	3888.00000	96	764.200000	144	213.400000
1	31040.0000	49	3742.00000	97	741.800000	145	208.400000
2	29500.0000	50	3602.00000	98	720.200000	146	203.600000
3	28060.0000	51	3468.00000	99	699.400000	147	198.800000
4	26680.0000	52	3340.00000	100	679.200000	148	194.200000
5	25400.0000	53	3216.00000	101	659.600000	149	189.700000
6	24180.0000	54	3098.00000	102	640.800000	150	185.400000
7	23020.0000	55	2986.00000	103	622.600000		

## Appendix 5 Parts and Accessories

Item #	Part Description
115250	BOARD,ASSY,IOEM-4,AQUACULTURE,SWI
115251	ELECTRONICS ASSY, IOEM-8,AQUACULTURE,SWI
115252	BOARD,ASSY,REM-4,AQUACULTURE,SWI
115253	STAINLESS STEEL LOCKING LATCH KIT, AQUACULTURE SWI
115254	COVER REPLACEMENT KIT, AQUACULTURE SWI
115255	COMPRESSION FITTING ASSEMBLY,3/8NPT,.16-.31,CABLE,RANGE ,AQUACULTURE,SWI
115256	COMPRESSION FITTING ASSEMBLY,1/2NPT,.24-.47CABLE,RANGE ,AQUACULTURE,SW
115257	COMPRESION FITTING ASSEMBLY,3/4NPT,.51-.71,CABLE,RANGE ,AQUACULTURE,SWI
115258	MOUNTING,FEET,KIT,PREMIUM,LINE,AQUACULTURE,SWI

## Appendix 6 Warranty

YSI IOEM and REM instruments are warranted by YSI for two years from date of purchase by the end user against defects in materials and workmanship (excluding components and materials for YSI IOEM and REM devices which are separately warranted below). All YSI cables, probe modules, and sensors for the YSI IOEM and REM are warranted by YSI for one year from date of purchase by the end user against defects in material and workmanship. Within the applicable warranty period, YSI will repair or replace, at its sole discretion, free of charge, any product that YSI determines to be covered by this warranty.

To exercise this warranty, call your local YSI representative, or contact YSI customer service in Yellow Springs, Ohio at +1 937 767-7241. Send the product and proof of purchase, transportation prepaid, to the Authorized Service Center selected by YSI. Repair or replacement will be made and the product returned, transportation prepaid. Repaired or replaced products are warranted for the balance of the original warranty period, or at least 90 days from date of repair or replacement. The end user making a claim under any of these warranties is responsible for all product removal and reinstallation costs related to any product repair or replacement under any such warranty.

### Limitation of Warranty

This warranty does not apply to any YSI product damage or failure caused by:

1. failure to install, operate or use the product in accordance with YSI's written instructions;
2. abuse or misuse of the product;
3. failure to maintain the product in accordance with YSI's written instructions or standard industry procedure;
4. any improper, incorrect or substandard repairs to the product not performed by YSI;
5. use by anyone (other than YSI) of any defective or improper component or part in servicing or repairing the product;
6. modification of the product in any way not expressly authorized by YSI.

THIS WARRANTY IS IN LIEU OF ALL OTHER WARRANTIES, EXPRESSED OR IMPLIED, INCLUDING ANY WARRANTY OF MERCHANTABILITY OR FITNESS FOR A PARTICULAR PURPOSE. YSI'S LIABILITY UNDER THIS WARRANTY IS LIMITED TO REPAIR OR REPLACEMENT OF THE PRODUCT, AND THIS SHALL BE THE SOLE AND EXCLUSIVE REMEDY FOR ANY DEFECTIVE PRODUCT COVERED BY THIS WARRANTY. IN NO EVENT SHALL YSI BE LIABLE FOR ANY SPECIAL, INDIRECT, INCIDENTAL OR CONSEQUENTIAL DAMAGES RESULTING FROM OR CAUSED BY ANY DEFECTIVE PRODUCT COVERED BY THIS WARRANTY.

## Appendix 7 Contact Us

### Ordering and Technical Support

Please visit [www.yisi.com](http://www.yisi.com) for a list of YSI's locations worldwide along with additional contact information.

YSI, Inc. Corporate Headquarters:

Telephone: 800 897 4151 (US)  
+1 937 767 7241 (Globally)  
Monday through Friday, 8:00 AM to 5:00 ET

Fax: +1 937 767 1058

Email: [environmental@ysi.com](mailto:environmental@ysi.com)

Mail: YSI Incorporated  
1725 Brannum Lane  
Yellow Springs, OH 45387 USA

Web Site: [www.yisi.com](http://www.yisi.com)

When placing an order please have the following available:

- 1.) YSI account number (if available)
- 2.) Name and phone number
- 3.) Purchase Order or Credit Card
- 4.) Model Number or brief description
- 5.) Billing and shipping addresses
- 6.) Quantity

### Service Information

YSI has authorized service centers throughout the United States and Internationally. For the nearest service center information, please visit [www.yisi.com](http://www.yisi.com) and click 'Support' or contact YSI Technical Support directly at +1 937-767-7241.

When returning a product for service, include the Product Return form with cleaning certification. The form must be completely filled out for a YSI Service Center to accept the instrument for service. The form may be downloaded from [www.yisi.com](http://www.yisi.com) by clicking on the 'Support' tab, then the Product Return Form.

## Appendix 8 Recycling

### Recycling

YSI is committed to reducing the environmental footprint in the course of doing business. Even though materials reduction is the ultimate goal, we know there must be a concerted effort to responsibly deal with materials after they've served a long, productive life-cycle. YSI's recycling program ensures that old equipment is processed in an environmentally friendly way, reducing the amount of material going to landfills.

- Printed Circuit Boards are sent to facilities that process and reclaim as much material for recycling as possible.
- Plastics enter a material recycling process and are not incinerated or sent to landfills.
- Batteries are removed and sent to battery recyclers for dedicated metals.

When the time comes for you to recycle, follow the easy steps outlined at [www.yisi.com](http://www.yisi.com).

### Battery Disposal

The circuit board in this instrument contains a manganese dioxide lithium "coin cell" battery that must be in place for continuity of power to memory devices on the board. This battery is not user serviceable or replaceable. When appropriate, an authorized YSI service center will remove this battery and properly dispose of it, per service and repair policies.



# Index

## Symbols

- 5X00 instruments
  - 5X00 family of instruments 8
  - 5X00 systems 72

## A

- Accessories 92
- AquaManager
  - and system menu 82
- Auxiliary (Aux) systems
  - wiring 43
    - analog (non temperature) 45
    - digital 45

## B

- Bulkhead fittings 30
  - rubber grommets 30

## C

- Channel 71
- Configuration chapter 69
- Contact Us 94
- Control board 33

## E

- E-Aux
  - datalog 71
  - virtual system 72
- expansion module firmware updater directions 60

## F

- Ferrite bead installation 35
- Firmware Updater

- could not find unit error 65
- device timed out error 64
- directions to update firmware 60
- Unit is Up-To-Date message 65
- Front panel
  - open 32

## G

- Grounding
  - tanks 33

## H

- Hardware
  - bulkhead fittings 30
  - installation & wiring chapter 23
  - PCBs 28

## I

- Installation 24–44
  - Installation and wiring chapter 23
  - qualified installer 11
- IOEM
  - channel 71
  - I (inputs) O (outputs) 71
  - mode 72
- IOEM & REM location considerations 25

## L

- Lightning and Surge Protection 65
- Local machine 71
  - instrument and relay names at 5X00 instrument menus 71

## M

- Mode 72
- mount IOEM and REM 26

## N

- Network
  - wiring

loops 53  
   stars 53  
   stub 49  
 Network termination relay 56

**P**

Panel mount 5200A 27  
 Parts and accessories 92  
 PCBs (printed circuit boards) 28  
 Power (wire) 35  
   AC 35  
   DC and backup 38

**R**

Rail mount 5200A 26  
 Recycling 95  
 Relays  
   wiring 40  
 REM  
   channel 71  
 Remote machine 71  
   instrument and relay names at 5X00 instrument menus 71  
 RS232  
   PC connection 59

**S**

Safety  
   cautions 20  
   warnings 17  
 Specifications  
   sensors 13  
   systems (non input) 13–14  
     communication 14  
       RS232 14  
     firmware 14  
     hardware  
       relays 13  
 Stub (network wiring) 49  
 Surface mount 5200A 26  
 Surge and lightning protection 65

**T**

Table of Contents 3  
 Technical Support 94  
 Troubleshooting  
   AquaManager 87  
   email alarming 86  
   Feed Smart timer 87  
   firmware updater 86  
   network 86  
   other 5200A systems 86  
   relays 86

**W**

Warranty 93  
 Weather shield 27  
 Wiring  
   4/20mA output 47  
   aux (auxiliary inputs)  
     temperature 46  
   aux (non temperature)  
     analog instrument 45  
     digital instrument 45  
   bulkhead fittings 30  
   communication equipment  
     rs232 59  
   control board 33  
   PCBs 28  
   power  
     AC 35  
     DC 38  
       backup 38  
   relays (outputs) 40

Item # 606524  
Rev B  
Drawing # 606524  
April 22, 2015

©2015 YSI Incorporated