





MULTI CYCLONE 16

CENTRIFUGAL PRE-FILTRATION



Waterco's award winning MultiCyclone is a brilliant pre-filtration device that works on the basis of centrifugal water filtration and is designed with no moving parts and no filter media to clean or replace.

-  **Minimises filter maintenance and saves water**
-  **No filter media to clean or replace**
-  **Suitable for new and existing installations**
-  **2 year warranty**



Ease filter workload

MultiCyclone pre-filters up to 80% of the filter's incoming dirt load easing the workload of the swimming pool filter. As the MultiCyclone intercepts more and more dirt, the flow rate remains unchanged.

- ✓ Improving pool water circulation
- ✓ Enhancing the performance of the automatic pool cleaner and in floor cleaning system
- ✓ Allowing effective pool vacuuming without burdening the pool filter
- ✓ Minimising filter maintenance and saving water



Minimise backwash frequency

The installation of a MultiCyclone as a pre-filter to a sand filter can reduce its backwash frequency to once per year, resulting in a saving of up to 7,000 litres of water per year for an average domestic sized swimming pool.

Minimise cartridge cleaning and replacement

The installation of a MultiCyclone as a pre-filter to a cartridge filter can reduce filter cartridge cleaning and replacement to once per swimming season and even up to once per year, depending on the size of the cartridge filter.



Centrifugal water filtration

The MultiCyclone works on the basis of centrifugal water filtration. There are no moving parts to wear and tear, and no filter media to clean or replace.

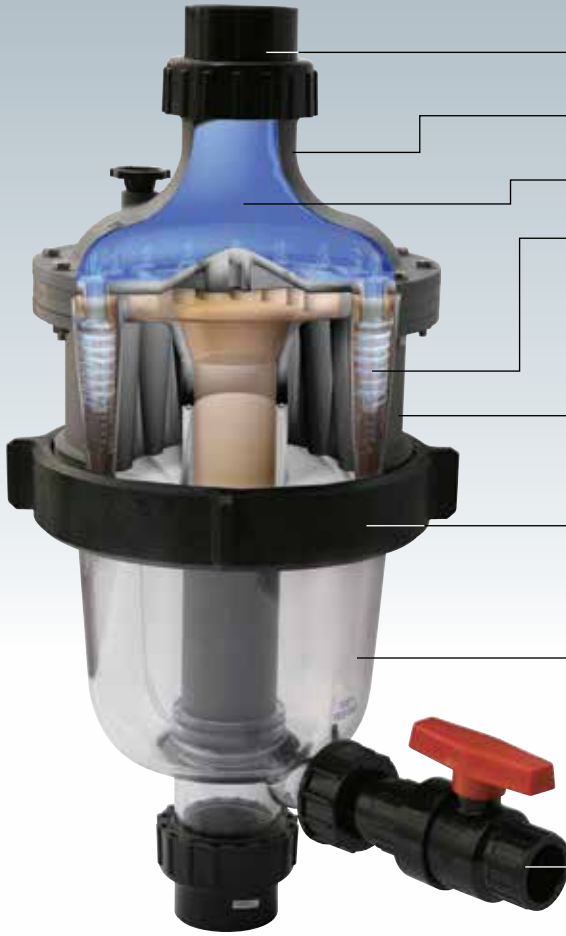

50mm / 2" quick fit unions

UV and corrosion proof

Hydraulically efficient design

16 multiple hydro cyclones

Glass filled reinforced thermoplastic

Lock ring

Clear poly carbonate sediment chamber

25mm / 1" sediment purge valve

- i. Incoming water enters 16 hydro cyclones tangentially, generating a strong centrifugal effect.
- ii. The sediment is spun out to the hydro cyclone's wall, and then spirals down to the sediment chamber*.
- iii. The filtered water migrates towards the centre of the hydro cyclone where the flow reverses and spirals upwards through the outlet.
- iv. Accumulation of sediment can be visibly monitored through the MultiCyclone's clear sediment chamber.

*Note: The MultiCyclone is designed to filter sediment that is heavier than water, floating debris cannot be filtered out by centrifugal filtration.

Simple maintenance

The MultiCyclone is easily cleaned by opening its purge valve. Only 15 litres of water is discharged to cleanse the MultiCyclone.



Specifications

Model	Connection Ports	Minimum Flow	Maximum Flow	Maximum Pressure
MultiCyclone 16	50mm / 2"	50lpm / 3m ³ /hr	500lpm / 30m ³ /hr	350 kPa (50psi)

Head Loss

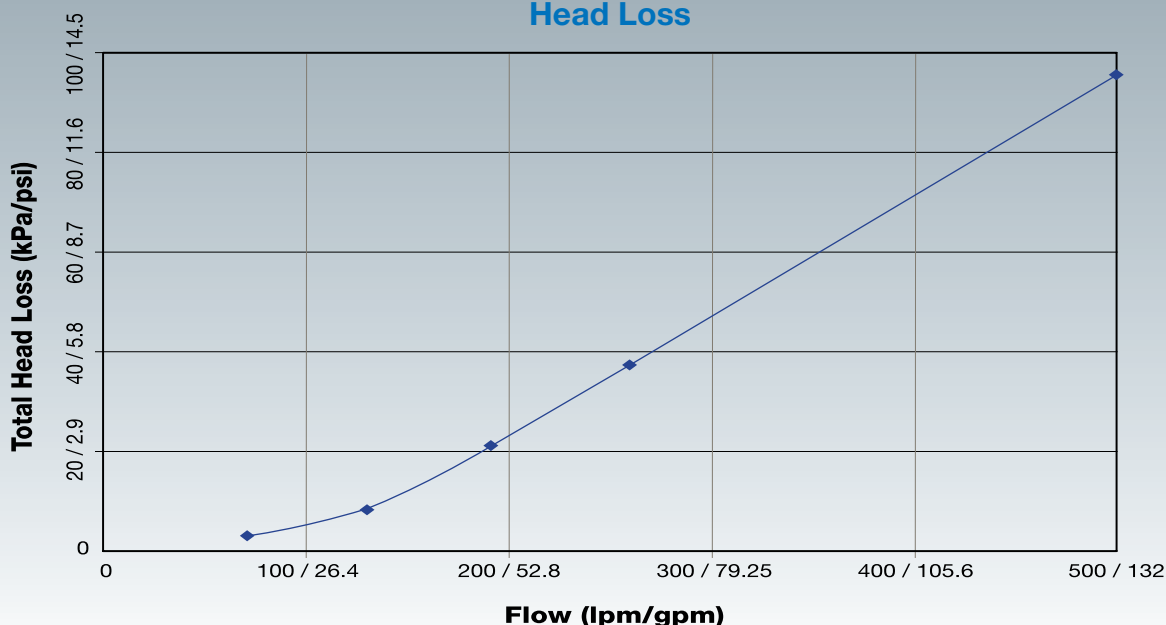

Dimensions (mm/in)

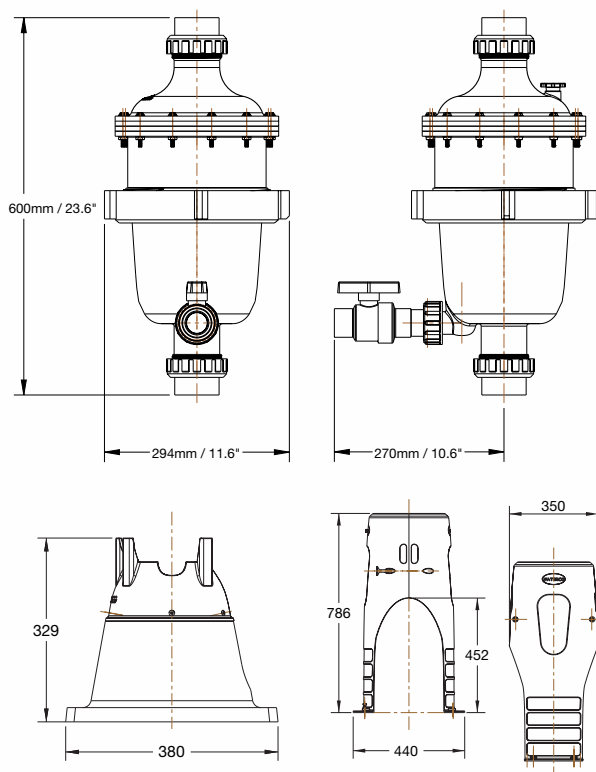

MultiCyclone Support Stands

The MultiCyclone has two purpose designed support stands to suit all MultiCyclone models and most installations.



MultiCyclone Stand MKII

MultiCyclone Pump Stand

MultiCyclone Stand MKII, a great option if the height of the installation is prohibitive.

Note: MultiCyclone Support Stand is suitable for most Waterco Domestic Pool Pumps. Excluding Hydrostar & all Commercial Pumps.

Warranty

MultiCyclone is covered by a 2 year warranty and 1 year warranty on labour. Commercial installations are covered by a 1 year warranty.

Note: When a Waterco Multicyclone Centrifugal Water Filter is installed within a swimming pool filtration system it is strongly recommended that no granular pool chemicals are added to the pool water through the pool skimmer box, unless there is the option to bypass the Multicyclone.

Note: All pool chemical or additives are to be added to the pool water as instructed by the manufacturer's procedures, only.

OFFICES - AUSTRALIA

NSW - Sydney (Head Office)
Tel: +61 2 9898 8600

QLD - Brisbane
Tel: +61 7 3299 9900

VIC/TAS - Melbourne
Tel: +61 3 9764 1211

WA - Perth
Tel: +61 8 9273 1900

SA/NT - Adelaide
Tel: +61 8 8244 6000

ACT Distribution
Tel: +61 2 6280 6476

OFFICES - OVERSEAS

Waterco (Europe) Limited
Sittingbourne, Kent, UK
Tel: +44 (0) 1795 521 733

Waterco (USA) Inc
Augusta, Georgia, USA
Tel: +1 706 793 7291

Waterco Canada
Longueuil, Quebec, Canada
Tel: +1 450 748 1421

Waterco (NZ) Limited
Auckland, New Zealand
Tel: +64 9 525 7570

Waterco (C) Limited
Guangzhou, China
Tel: +86 20 3222 2180

Waterco (Far East) Sdn Bhd
Selangor, Malaysia
Tel: +60 3 6145 6000

PT Waterco Indonesia
Jakarta, Indonesia
Tel: +62 21 4585 1481

Waterco Singapore Intl Pte Ltd
Nehsons Building, Singapore
Tel: +65 6344 2378

DISTRIBUTED BY:

WATERCO
water, the liquid of life

